

la ducha  
PLATOS DE DUCHA

# NATURE & NEO





NATURE  
& NEO

NATURE 110x210 blanco, acabado textura lisa, rejilla cuadrada inox





NATURE 90x120 blanco, acabado textura pizarra, rejilla redonda inox



NEO 90x190 ombra, acabado textura pizarra, rejilla redonda inox



NEO 90x120 color cacao, acabado textura pizarra, rejilla cuadrada



NEO 90x120 color creme, acabado textura pizarra, rejilla redonda inox



NEO 110x170 cement, acabado textura pizarra, rejilla cuadrada color, con marco en todo el lateral L3 y en medio lateral L4



Rejilla redonda inox



Rejilla redonda color blanco



Rejilla cuadrada inox

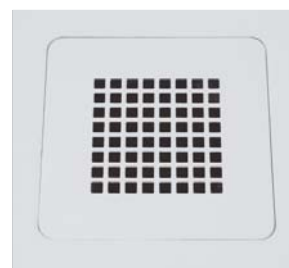

Rejilla cuadrada color blanco

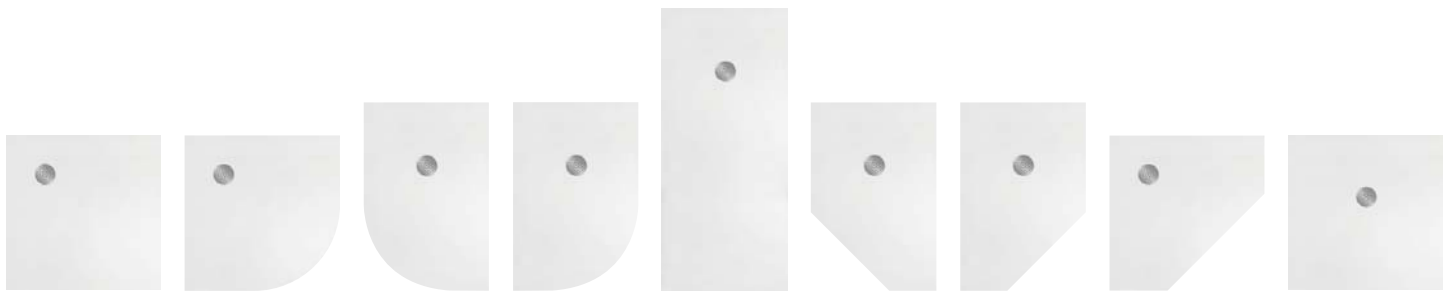

## ALTURA

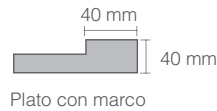

## INSTALACIÓN

## REJILLAS Y VÁLVULAS

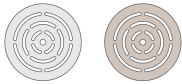

Incluye rejilla redonda inox  
Opcional del mismo color que el plato

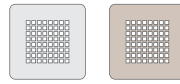

Opcional rejilla cuadrada inox o  
del mismo color que el plato

Incluida válvula Ø90 (UNE EN-274)  
Posibilidad de instalar con  
otras válvulas de Ø90

## ACABADO SUPERFICIAL



Acabado textura lisa



Acabado textura pizarra

Tratamiento Antislip Clase 3 (ENV 12633) | C (DIN 51097) | PN24 (XP P05-011). Incluido en Marmek®, opcional en Scene®

## MATERIALES Y COLORES

NATURE		NEO											
Scene		Marmek											
		COLOR BLANCO	COLOR STANDARD				COLOR SPECIAL						
	BLANCO		BIANCO		PIETRA		CAPPUCCINO		GRIS		IRON		RAL* / NCS*
			CREME		TERRA		CEMENT		OMBRA				
			BEIGE		CACAO		STEEL		GRAPHITE				

\* Los colores se suministran en gama mate. No se aceptan pedidos de colores brillo o efectos metálicos puesto que se alterarían las características en el producto. Ante cualquier duda, infórmese en nuestro servicio de atención al cliente.



		NATURE				NEO			
		Scene				marmek			
		COLOR BLANCO		COLOR BIANCO		COLOR STANDARD		COLOR SPECIAL	
		textura lisa	textura pizarra	textura lisa	textura pizarra	textura lisa	textura pizarra	textura lisa	textura pizarra
70	80-90	SNAC 0001	SNAC 0078	SNAC 0181	SNAC 0258	SNAC 0361	SNAC 0438	SNAC 0541	SNAC 0618
	91-100	SNAC 0002	SNAC 0079	SNAC 0182	SNAC 0259	SNAC 0362	SNAC 0439	SNAC 0542	SNAC 0619
	101-110	SNAC 0003	SNAC 0080	SNAC 0183	SNAC 0260	SNAC 0363	SNAC 0440	SNAC 0543	SNAC 0620
	111-120	SNAC 0004	SNAC 0081	SNAC 0184	SNAC 0261	SNAC 0364	SNAC 0441	SNAC 0544	SNAC 0621
	121-130	SNAC 0005	SNAC 0082	SNAC 0185	SNAC 0262	SNAC 0365	SNAC 0442	SNAC 0545	SNAC 0622
	131-140	SNAC 0006	SNAC 0083	SNAC 0186	SNAC 0263	SNAC 0366	SNAC 0443	SNAC 0546	SNAC 0623
	141-150	SNAC 0007	SNAC 0084	SNAC 0187	SNAC 0264	SNAC 0367	SNAC 0444	SNAC 0547	SNAC 0624
	151-160	SNAC 0008	SNAC 0085	SNAC 0188	SNAC 0265	SNAC 0368	SNAC 0445	SNAC 0548	SNAC 0625
	161-170	SNAC 0009	SNAC 0086	SNAC 0189	SNAC 0266	SNAC 0369	SNAC 0446	SNAC 0549	SNAC 0626
	171-180	SNAC 0010	SNAC 0087	SNAC 0190	SNAC 0267	SNAC 0370	SNAC 0447	SNAC 0550	SNAC 0627
	181-190	SNAC 0011	SNAC 0088	SNAC 0191	SNAC 0268	SNAC 0371	SNAC 0448	SNAC 0551	SNAC 0628
	191-200	SNAC 0012	SNAC 0089	SNAC 0192	SNAC 0269	SNAC 0372	SNAC 0449	SNAC 0552	SNAC 0629
	201-210	SNAC 0013	SNAC 0090	SNAC 0193	SNAC 0270	SNAC 0373	SNAC 0450	SNAC 0553	SNAC 0630
71-75	80-90	SNAC 0014	SNAC 0091	SNAC 0194	SNAC 0271	SNAC 0374	SNAC 0451	SNAC 0554	SNAC 0631
	91-100	SNAC 0015	SNAC 0092	SNAC 0195	SNAC 0272	SNAC 0375	SNAC 0452	SNAC 0555	SNAC 0632
	101-110	SNAC 0016	SNAC 0093	SNAC 0196	SNAC 0273	SNAC 0376	SNAC 0453	SNAC 0556	SNAC 0633
	111-120	SNAC 0017	SNAC 0094	SNAC 0197	SNAC 0274	SNAC 0377	SNAC 0454	SNAC 0557	SNAC 0634
	121-130	SNAC 0018	SNAC 0095	SNAC 0198	SNAC 0275	SNAC 0378	SNAC 0455	SNAC 0558	SNAC 0635
	131-140	SNAC 0019	SNAC 0096	SNAC 0199	SNAC 0276	SNAC 0379	SNAC 0456	SNAC 0559	SNAC 0636
	141-150	SNAC 0020	SNAC 0097	SNAC 0200	SNAC 0277	SNAC 0380	SNAC 0457	SNAC 0560	SNAC 0637
	151-160	SNAC 0021	SNAC 0098	SNAC 0201	SNAC 0278	SNAC 0381	SNAC 0458	SNAC 0561	SNAC 0638
	161-170	SNAC 0022	SNAC 0099	SNAC 0202	SNAC 0279	SNAC 0382	SNAC 0459	SNAC 0562	SNAC 0639
	171-180	SNAC 0023	SNAC 0100	SNAC 0203	SNAC 0280	SNAC 0383	SNAC 0460	SNAC 0563	SNAC 0640
	181-190	SNAC 0024	SNAC 0101	SNAC 0204	SNAC 0281	SNAC 0384	SNAC 0461	SNAC 0564	SNAC 0641
	191-200	SNAC 0025	SNAC 0102	SNAC 0205	SNAC 0282	SNAC 0385	SNAC 0462	SNAC 0565	SNAC 0642
	201-210	SNAC 0026	SNAC 0103	SNAC 0206	SNAC 0283	SNAC 0386	SNAC 0463	SNAC 0566	SNAC 0643

		NATURE		NEO					
		Scene		marmek					
		COLOR BLANCO		COLOR BIANCO		COLOR STANDARD		COLOR SPECIAL	
		textura lisa	textura pizarra	textura lisa	textura pizarra	textura lisa	textura pizarra	textura lisa	textura pizarra
76-80	80-90	SNAC 0027	SNAC 0104	SNAC 0207	SNAC 0284	SNAC 0387	SNAC 0464	SNAC 0567	SNAC 0644
	91-100	SNAC 0028	SNAC 0105	SNAC 0208	SNAC 0285	SNAC 0388	SNAC 0465	SNAC 0568	SNAC 0645
	101-110	SNAC 0029	SNAC 0106	SNAC 0209	SNAC 0286	SNAC 0389	SNAC 0466	SNAC 0569	SNAC 0646
	111-120	SNAC 0030	SNAC 0107	SNAC 0210	SNAC 0287	SNAC 0390	SNAC 0467	SNAC 0570	SNAC 0647
	121-130	SNAC 0031	SNAC 0108	SNAC 0211	SNAC 0288	SNAC 0391	SNAC 0468	SNAC 0571	SNAC 0648
	131-140	SNAC 0032	SNAC 0109	SNAC 0212	SNAC 0289	SNAC 0392	SNAC 0469	SNAC 0572	SNAC 0649
	141-150	SNAC 0033	SNAC 0110	SNAC 0213	SNAC 0290	SNAC 0393	SNAC 0470	SNAC 0573	SNAC 0650
	151-160	SNAC 0034	SNAC 0111	SNAC 0214	SNAC 0291	SNAC 0394	SNAC 0471	SNAC 0574	SNAC 0651
	161-170	SNAC 0035	SNAC 0112	SNAC 0215	SNAC 0292	SNAC 0395	SNAC 0472	SNAC 0575	SNAC 0652
	171-180	SNAC 0036	SNAC 0113	SNAC 0216	SNAC 0293	SNAC 0396	SNAC 0473	SNAC 0576	SNAC 0653
	181-190	SNAC 0037	SNAC 0114	SNAC 0217	SNAC 0294	SNAC 0397	SNAC 0474	SNAC 0577	SNAC 0654
	191-200	SNAC 0038	SNAC 0115	SNAC 0218	SNAC 0295	SNAC 0398	SNAC 0475	SNAC 0578	SNAC 0655
	201-210	SNAC 0039	SNAC 0116	SNAC 0219	SNAC 0296	SNAC 0399	SNAC 0476	SNAC 0579	SNAC 0656
81-90	80-90	SNAC 0040	SNAC 0117	SNAC 0220	SNAC 0297	SNAC 0400	SNAC 0477	SNAC 0580	SNAC 0657
	91-100	SNAC 0041	SNAC 0118	SNAC 0221	SNAC 0298	SNAC 0401	SNAC 0478	SNAC 0581	SNAC 0658
	101-110	SNAC 0042	SNAC 0119	SNAC 0222	SNAC 0299	SNAC 0402	SNAC 0479	SNAC 0582	SNAC 0659
	111-120	SNAC 0043	SNAC 0120	SNAC 0223	SNAC 0300	SNAC 0403	SNAC 0480	SNAC 0583	SNAC 0660
	121-130	SNAC 0044	SNAC 0121	SNAC 0224	SNAC 0301	SNAC 0404	SNAC 0481	SNAC 0584	SNAC 0661
	131-140	SNAC 0045	SNAC 0122	SNAC 0225	SNAC 0302	SNAC 0405	SNAC 0482	SNAC 0585	SNAC 0662
	141-150	SNAC 0046	SNAC 0123	SNAC 0226	SNAC 0303	SNAC 0406	SNAC 0483	SNAC 0586	SNAC 0663
	151-160	SNAC 0047	SNAC 0124	SNAC 0227	SNAC 0304	SNAC 0407	SNAC 0484	SNAC 0587	SNAC 0664
	161-170	SNAC 0048	SNAC 0125	SNAC 0228	SNAC 0305	SNAC 0408	SNAC 0485	SNAC 0588	SNAC 0665
	171-180	SNAC 0049	SNAC 0126	SNAC 0229	SNAC 0306	SNAC 0409	SNAC 0486	SNAC 0589	SNAC 0666
	181-190	SNAC 0050	SNAC 0127	SNAC 0230	SNAC 0307	SNAC 0410	SNAC 0487	SNAC 0590	SNAC 0667
	191-200	SNAC 0051	SNAC 0128	SNAC 0231	SNAC 0308	SNAC 0411	SNAC 0488	SNAC 0591	SNAC 0668
	201-210	SNAC 0052	SNAC 0129	SNAC 0232	SNAC 0309	SNAC 0412	SNAC 0489	SNAC 0592	SNAC 0669

# NATURE & NEO

la ducha  
PLATOS DE DUCHA  
tarifa

		NATURE				NEO			
		Scene				marmek			
		COLOR BLANCO		COLOR BIANCO		COLOR STANDARD		COLOR SPECIAL	
		textura lisa	textura pizarra	textura lisa	textura pizarra	textura lisa	textura pizarra	textura lisa	textura pizarra
91-100	100-110	SNAC 0053	SNAC 0130	SNAC 0233	SNAC 0310	SNAC 0413	SNAC 0490	SNAC 0593	SNAC 0670
	111-120	SNAC 0054	SNAC 0131	SNAC 0234	SNAC 0311	SNAC 0414	SNAC 0491	SNAC 0594	SNAC 0671
	121-130	SNAC 0055	SNAC 0132	SNAC 0235	SNAC 0312	SNAC 0415	SNAC 0492	SNAC 0595	SNAC 0672
	131-140	SNAC 0056	SNAC 0133	SNAC 0236	SNAC 0313	SNAC 0416	SNAC 0493	SNAC 0596	SNAC 0673
	141-150	SNAC 0057	SNAC 0134	SNAC 0237	SNAC 0314	SNAC 0417	SNAC 0494	SNAC 0597	SNAC 0674
	151-160	SNAC 0058	SNAC 0135	SNAC 0238	SNAC 0315	SNAC 0418	SNAC 0495	SNAC 0598	SNAC 0675
	161-170	SNAC 0059	SNAC 0136	SNAC 0239	SNAC 0316	SNAC 0419	SNAC 0496	SNAC 0599	SNAC 0676
	171-180	SNAC 0060	SNAC 0137	SNAC 0240	SNAC 0317	SNAC 0420	SNAC 0497	SNAC 0600	SNAC 0677
	181-190	SNAC 0061	SNAC 0138	SNAC 0241	SNAC 0318	SNAC 0421	SNAC 0498	SNAC 0601	SNAC 0678
	191-200	SNAC 0062	SNAC 0139	SNAC 0242	SNAC 0319	SNAC 0422	SNAC 0499	SNAC 0602	SNAC 0679
	201-210	SNAC 0063	SNAC 0140	SNAC 0243	SNAC 0320	SNAC 0423	SNAC 0500	SNAC 0603	SNAC 0680
101-110	100-110	SNAC 0064	SNAC 0141	SNAC 0244	SNAC 0321	SNAC 0424	SNAC 0501	SNAC 0604	SNAC 0681
	111-120	SNAC 0065	SNAC 0142	SNAC 0245	SNAC 0322	SNAC 0425	SNAC 0502	SNAC 0605	SNAC 0682
	121-130	SNAC 0066	SNAC 0143	SNAC 0246	SNAC 0323	SNAC 0426	SNAC 0503	SNAC 0606	SNAC 0683
	131-140	SNAC 0067	SNAC 0144	SNAC 0247	SNAC 0324	SNAC 0427	SNAC 0504	SNAC 0607	SNAC 0684
	141-150	SNAC 0068	SNAC 0145	SNAC 0248	SNAC 0325	SNAC 0428	SNAC 0505	SNAC 0608	SNAC 0685
	151-160	SNAC 0069	SNAC 0146	SNAC 0249	SNAC 0326	SNAC 0429	SNAC 0506	SNAC 0609	SNAC 0686
	161-170	SNAC 0070	SNAC 0147	SNAC 0250	SNAC 0327	SNAC 0430	SNAC 0507	SNAC 0610	SNAC 0687
	171-180	SNAC 0721	SNAC 0148	SNAC 0725	SNAC 0328	SNAC 0729	SNAC 0508	SNAC 0733	SNAC 0688
	181-190	SNAC 0722	SNAC 0149	SNAC 0726	SNAC 0329	SNAC 0730	SNAC 0509	SNAC 0734	SNAC 0689
	191-200	SNAC 0723	SNAC 0150	SNAC 0727	SNAC 0330	SNAC 0731	SNAC 0510	SNAC 0735	SNAC 0690
	201-210	SNAC 0724	SNAC 0151	SNAC 0728	SNAC 0331	SNAC 0732	SNAC 0511	SNAC 0736	SNAC 0691

		NATURE		NEO					
		Scene		marmek					
		COLOR BLANCO		COLOR BIANCO		COLOR STANDARD		COLOR SPECIAL	
		textura lisa	textura pizarra	textura lisa	textura pizarra	textura lisa	textura pizarra	textura lisa	textura pizarra
Rectangular	111-120	120-130	- SNAC 0152	- SNAC 0332	- SNAC 0512	- SNAC 0692	- SNAC 0512	- SNAC 0692	- SNAC 0692
	131-140	- SNAC 0153	- SNAC 0333	- SNAC 0513	- SNAC 0693	- SNAC 0513	- SNAC 0693	- SNAC 0693	- SNAC 0693
	141-150	- SNAC 0154	- SNAC 0334	- SNAC 0514	- SNAC 0694	- SNAC 0514	- SNAC 0694	- SNAC 0694	- SNAC 0694
	151-160	- SNAC 0155	- SNAC 0335	- SNAC 0515	- SNAC 0695	- SNAC 0515	- SNAC 0695	- SNAC 0695	- SNAC 0695
	161-170	- SNAC 0156	- SNAC 0336	- SNAC 0516	- SNAC 0696	- SNAC 0516	- SNAC 0696	- SNAC 0696	- SNAC 0696
	171-180	- SNAC 0157	- SNAC 0337	- SNAC 0517	- SNAC 0697	- SNAC 0517	- SNAC 0697	- SNAC 0697	- SNAC 0697
Cuadrado	121-130	120-130	- SNAC 0158	- SNAC 0338	- SNAC 0518	- SNAC 0698	- SNAC 0518	- SNAC 0698	- SNAC 0698
	131-140	- SNAC 0159	- SNAC 0339	- SNAC 0519	- SNAC 0699	- SNAC 0519	- SNAC 0699	- SNAC 0699	- SNAC 0699
	141-150	- SNAC 0160	- SNAC 0340	- SNAC 0520	- SNAC 0700	- SNAC 0520	- SNAC 0700	- SNAC 0700	- SNAC 0700
	151-160	- SNAC 0161	- SNAC 0341	- SNAC 0521	- SNAC 0701	- SNAC 0521	- SNAC 0701	- SNAC 0701	- SNAC 0701
	161-170	- SNAC 0162	- SNAC 0342	- SNAC 0522	- SNAC 0702	- SNAC 0522	- SNAC 0702	- SNAC 0702	- SNAC 0702
	171-180	- 1.009 SNAC 0163	- SNAC 0343	- SNAC 0523	- SNAC 0703	- SNAC 0523	- SNAC 0703	- SNAC 0703	- SNAC 0703
80-100	131-140	120-130	- SNAC 0164	- SNAC 0344	- SNAC 0524	- SNAC 0704	- SNAC 0524	- SNAC 0704	- SNAC 0704
	131-140	- SNAC 0165	- SNAC 0345	- SNAC 0525	- SNAC 0705	- SNAC 0525	- SNAC 0705	- SNAC 0705	- SNAC 0705
80-100	80-90	SNAC 0071	SNAC 0166	SNAC 0251	SNAC 0346	SNAC 0431	SNAC 0526	SNAC 0611	SNAC 0706
	91-100	SNAC 0072	SNAC 0167	SNAC 0252	SNAC 0347	SNAC 0432	SNAC 0527	SNAC 0612	SNAC 0707

# NATURE & NEO

la ducha  
PLATOS DE DUCHA  
tarifa

		NATURE		NEO						
		Scene		marmek						
		COLOR BLANCO		COLOR BIANCO		COLOR STANDARD		COLOR SPECIAL		
		textura lisa	textura pizarra	textura lisa	textura pizarra	textura lisa	textura pizarra	textura lisa	textura pizarra	
Angular	80	80	SNAC 0073	SNAC 0168	SNAC 0253	SNAC 0348	SNAC 0433	SNAC 0528	SNAC 0613	SNAC 0708
	90	90	SNAC 0074	SNAC 0169	SNAC 0254	SNAC 0349	SNAC 0434	SNAC 0529	SNAC 0614	SNAC 0709
	100	100	SNAC 0075	SNAC 0170	SNAC 0255	SNAC 0350	SNAC 0435	SNAC 0530	SNAC 0615	SNAC 0710
Angular R	80	120	-	SNAC 0171	-	SNAC 0351	-	SNAC 0531	-	SNAC 0711
	90	120	-	SNAC 0172	-	SNAC 0352	-	SNAC 0532	-	SNAC 0712
	100	120	-	SNAC 0173	-	SNAC 0353	-	SNAC 0533	-	SNAC 0713
Angular L	80	120	-	SNAC 0174	-	SNAC 0354	-	SNAC 0534	-	SNAC 0714
	90	120	-	SNAC 0175	-	SNAC 0355	-	SNAC 0535	-	SNAC 0715
	100	120	-	SNAC 0176	-	SNAC 0356	-	SNAC 0536	-	SNAC 0716
Pentagonal	80	90	SNAC 0076	SNAC 0175	SNAC 0256	SNAC 0355	SNAC 0436	SNAC 0535	SNAC 0616	SNAC 0715
	90	90	SNAC 0077	SNAC 0176	SNAC 0257	SNAC 0356	SNAC 0437	SNAC 0536	SNAC 0617	SNAC 0716
	100	100	-	SNAC 0177	-	SNAC 0357	-	SNAC 0537	-	SNAC 0717
Pentagonal R	80	120	-	SNAC 0178	-	SNAC 0358	-	SNAC 0538	-	SNAC 0718
	90	120	-	SNAC 0179	-	SNAC 0359	-	SNAC 0539	-	SNAC 0719
	100	120	-	SNAC 0180	-	SNAC 0360	-	SNAC 0540	-	SNAC 0720
Pentagonal L	80	120	-	SNAC 0179	-	SNAC 0359	-	SNAC 0539	-	SNAC 0719
	90	120	-	SNAC 0180	-	SNAC 0360	-	SNAC 0540	-	SNAC 0720
	100	120	-	SNAC 0180	-	SNAC 0360	-	SNAC 0540	-	SNAC 0720

NATURE & NEO

código

ancho

largo

material

- Scene (Nature)
- Marmek (Neo)

color

- Scene (Nature)
  - blanco
- Marmek (Neo)
  - blanco
  - standard
  - special

textura

- liso
- pizarra

forma

- rectangular
- cuadrado
- angular
- pentagonal

REJILLA VÁLVULA



**incluido** Rejilla redonda



+ Rejilla cuadrada



+ Rejilla redonda con el mismo color que el plato de ducha



+ Rejilla cuadrada con el mismo color que el plato de ducha

VÁLVULA

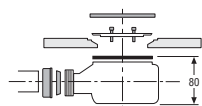

**incluido** Válvula salida horizontal Viega 90 Tempoplex  
Según norma EN-274

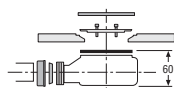

+ Válvula salida horizontal Viega 90 Tempoplex extraplana

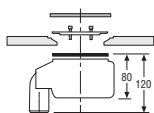

+ Válvula salida vertical Viega 90 Tempoplex  
Según norma EN-274

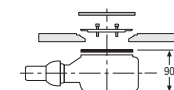

+ Válvula salida horizontal Viega 90 Tempoplex Plus

TRATAMIENTO ANTISLIP



**incluido** Tratamiento Antislip Clase 3 ENV 12633 | C (DIN 51097) | PN24 (XP P05-011), para Marmek®



+ Tratamiento Antislip Clase 3 ENV 12633 | C (DIN 51097) | PN24 (XP P05-011), para Scene®

CORTE



**incluido** Cortes longitudinales en ancho y largo cm a cm



+ Cortes especiales cm a cm  
Los pedidos serán confirmados mediante plano técnico



MARCO

Marco liso sobre lateral L1/L2/L3/L4 a indicar. Precio por cm lineal

Para platos rectangulares y cuadrados.

Indicar los lados completos donde instalar el marco (únicamente en lados rectos)

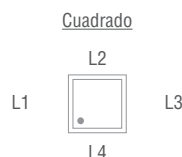
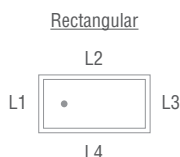

Otras configuraciones

Marcos especiales y/o parciales

Los pedidos serán confirmados mediante plano técnico



# NATURE & NEO

la ducha  
PLATOS DE DUCHA  
información técnica

## PLATO DE DUCHA NATURE & NEO RECTANGULAR / NATURE & NEO RECTANGULAR SHOWER TRAY / RECEVEUR DE DOUCHE NATURE & NEO RECTANGULAIRE / BASE DE CHUVEIRO NATURE & NEO RETANGULAR

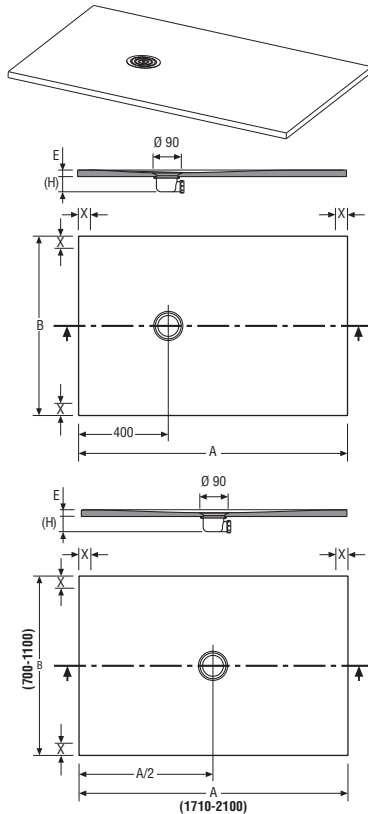

A	B	E	V	P	A	B	E	V	P	A	B	E	V	P	A	B	E	V	P				
800	700	30	0,047	30	800	750	30	0,047	32	800	800	30	0,047	34	800	900	30	0,047	38				
810	→ 900	700	30	0,047	33	810	→ 900	750	30	0,047	36	810	→ 900	800	30	0,047	39	810	→ 900	900	30	0,047	43
910	→ 1000	700	30	0,047	37	910	→ 1000	750	30	0,047	40	910	→ 1000	800	30	0,047	43	910	→ 1000	900	30	0,047	48
1010	→ 1100	700	30	0,056	41	1010	→ 1100	750	30	0,056	44	1010	→ 1100	800	30	0,056	47	1010	→ 1100	900	30	0,056	52
1110	→ 1200	700	30	0,056	45	1110	→ 1200	750	30	0,056	48	1110	→ 1200	800	30	0,056	53	1110	→ 1200	900	30	0,056	57
1210	→ 1300	700	30	0,065	48	1210	→ 1300	750	30	0,065	52	1210	→ 1300	800	30	0,065	53	1210	→ 1300	900	30	0,065	62
1310	→ 1400	700	30	0,065	52	1310	→ 1400	750	30	0,065	56	1310	→ 1400	800	30	0,065	60	1310	→ 1400	900	30	0,065	67
1410	→ 1500	700	30	0,079	55	1410	→ 1500	750	30	0,079	59	1410	→ 1500	800	30	0,079	64	1410	→ 1500	900	30	0,079	71
1510	→ 1600	700	30	0,079	59	1510	→ 1600	750	30	0,079	64	1510	→ 1600	800	30	0,079	68	1510	→ 1600	900	30	0,079	76
1610	→ 1700	700	30	0,079	63	1610	→ 1700	750	30	0,079	68	1610	→ 1700	800	30	0,079	73	1610	→ 1700	900	30	0,079	86
1710	→ 1800	700	30	0,088	66	1710	→ 1800	750	30	0,088	71	1710	→ 1800	800	30	0,088	76	1710	→ 1800	900	30	0,088	84
1810	→ 1900	700	30	0,088	70	1810	→ 1900	750	30	0,088	75	1810	→ 1900	800	30	0,088	81	1810	→ 1900	900	30	0,088	90
1910	→ 2000	700	30	0,098	73	1910	→ 2000	750	30	0,098	79	1910	→ 2000	800	30	0,098	84	1910	→ 2000	900	30	0,098	94
2010	→ 2100	700	30	0,098	77	2010	→ 2100	750	30	0,098	83	2010	→ 2100	800	30	0,098	89	2010	→ 2100	900	30	0,098	99

A	B	E	V	P	A	B	E	V	P	A	B	E	V	P	A	B	E	V	P				
1000	→ 1100	1000	30	0,068	57	1000	→ 1100	1100	30	0,068	64	1000	→ 1300	1200	30	0,083	87	1200	→ 1300	1300	30	0,090	96
1110	→ 1200	1000	30	0,068	63	1110	→ 1200	1100	30	0,068	70	1310	→ 1400	1200	30	0,089	94	1310	→ 1400	1300	30	0,096	104
1210	→ 1300	1000	30	0,074	68	1210	→ 1300	1100	30	0,074	75	1410	→ 1500	1200	30	0,095	101	1410	→ 1500	1300	30	0,103	109
1310	→ 1400	1000	30	0,080	74	1310	→ 1400	1100	30	0,080	82	1510	→ 1600	1200	30	0,102	108	1510	→ 1600	1300	30	0,110	119
1410	→ 1500	1000	30	0,085	77	1410	→ 1500	1100	30	0,085	85	1610	→ 1700	1200	30	0,108	114	1610	→ 1700	1300	30	0,117	124
1510	→ 1600	1000	30	0,091	83	1510	→ 1600	1100	30	0,091	92	1710	→ 1800	1200	30	0,114	121	1710	→ 1800	1300	30	0,123	135
1610	→ 1700	1000	30	0,096	89	1610	→ 1700	1100	30	0,096	99	1200	→ 1300	1400	30	0,096	104	1310	→ 1400	1400	30	0,104	114
1710	→ 1800	1000	30	0,099	92	1710	→ 1800	1100	30	0,108	102												
1810	→ 1900	1000	30	0,104	98	1810	→ 1900	1100	30	0,114	109												
1910	→ 2000	1000	30	0,109	102	1910	→ 2000	1100	30	0,119	114												
2010	→ 2100	1000	30	0,114	108	2010	→ 2100	1100	30	0,125	120												

Medidas en mm / Sizes in mm / Mesures en mm / Medidas en mm

## PLATO DE DUCHA NATURE & NEO PENTAGONAL / NATURE & NEO PENTAGONAL SHOWER TRAY / RECEVEUR DE DOUCHE NATURE & NEO PENTAGONAL / BASE DE CHUVEIRO NATURE & NEO PENTAGONAL

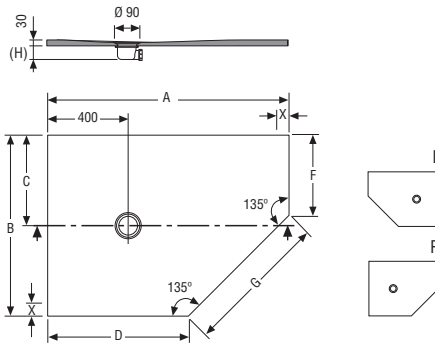
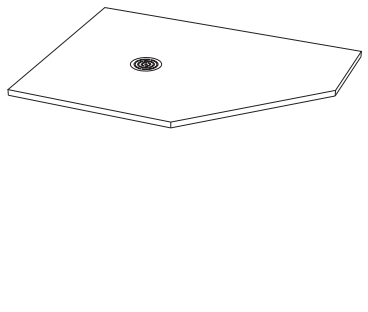

A	B	C	D	G	F	V	P
1200	800	400	700	710	300	0,056	42
1200	900	450	700	710	400	0,056	48

Medidas en mm / Sizes in mm / Mesures en mm / Medidas en mm

## PLATO DE DUCHA NATURE & NEO ANGULAR / NATURE & NEO ANGULAR SHOWER TRAY / RECEVEUR DE DOUCHE NATURE & NEO D'ANGLE / BASE DE CHUVEIRO NATURE & NEO ANGULAR

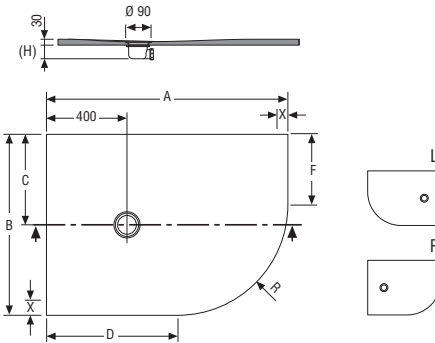
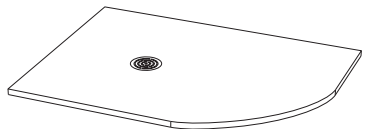

A	B	C	D	F	R	V	P
1200	800	400	650	250	550	0,056	42
1200	900	450	650	350	550	0,056	48

Medidas en mm / Sizes in mm / Mesures en mm / Medidas en mm

V Volumen de expedición sin palet (m3) | Shipping volume without palet | Volume à l'expédition sans palet | Volume expedição sin palet

P Peso de expedición sin palet (Kg) | Shipping weight without palet | Poids à l'expédition sans palet | Peso de expedição sin palet

X Zona emplazamiento mampara. El espacio mínimo reservado para la mampara es de 30 mm | Glass enclosure zone. The minimum area reserved for the glass enclosure is 30 mm | Zone d'emplacement de la paroi de douche | L'espace minimum réservé à la paroi est de 30 mm | Zona de colocação da divisória. O espaço mínimo necessário à divisória é de 30 mm

(H) Medida en función del desagüe suministrado | Height according to valve supplied | Mesure en fonction du vidage livré | Medida em função da válvula fornecida

PLATO DE DUCHA NATURE & NEO CUADRADO / NATURE & NEO SQUARE SHOWER TRAY / RECEVEUR DE DOUCHE NATURE & NEO CARRÉ / BASE DE CHUVEIRO NATURE & NEO QUADRADO

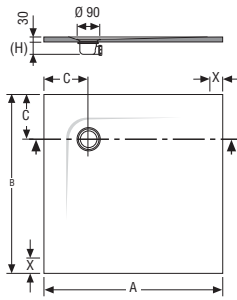
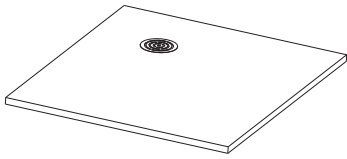

A	B	C	V	P
800	800	150	0,047	36
900	900	200	0,047	44
1000	1000	250	0,068	54

Medidas en mm / Sizes in mm  
Mesures en mm / Medidas em mm

PLATO DE DUCHA NATURE & NEO PENTAGONAL / NATURE & NEO PENTAGONAL SHOWER TRAY / RECEVEUR DE DOUCHE NATURE & NEO PENTAGONAL / BASE DE CHUVEIRO NATURE & NEO PENTAGONAL

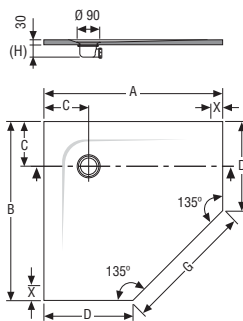
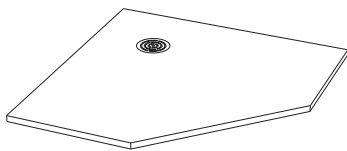

A	B	C	D	G	V	P
900	900	170	400	710	0,047	35
1000	1000	250	500	710	0,068	45

Medidas en mm / Sizes in mm  
Mesures en mm / Medidas em mm

PLATO DE DUCHA NATURE & NEO ANGULAR / NATURE & NEO ANGULAR SHOWER TRAY / RECEVEUR DE DOUCHE NATURE & NEO D'ANGLE / BASE DE CHUVEIRO NATURE & NEO ANGULAR

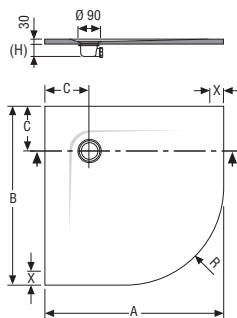
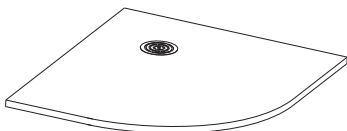

A	B	C	R	V	P
800	800	150	550	0,047	31
900	900	200	550	0,047	39
1000	1000	250	550	0,068	50

Medidas en mm / Sizes in mm  
Mesures en mm / Medidas em mm

- V** Volumen de expedición sin palet (m3) | Shipping volume without pallet | Volume à l'expédition sans palet | Volume expedição sin palet  
**P** Peso de expedición sin palet (Kg) | Shipping weight without pallet | Poids à l'expédition sans palet | Peso de expedição sin palet  
**X** Zona emplazamiento mampara. El espacio mínimo reservado para la mampara es de 30 mm | Glass enclosure zone. The minimum area reserved for the glass enclosure is 30 mm | Zone d'emplacement de la paroi de douche | L'espace minimum réservé à la paroi est de 30 mm | Zona de colocação da divisória. O espaço mínimo necessário à divisória é de 30 mm  
**(H)** Medida en función del desagüe suministrado | Height according to valve supplied | Mesure en fonction du vidage livré | Medida em função da válvula fornecida