

CATALOGO LISTINO PRICE LIST CATALOGUE

2015



**PRODOTTI ISPIRATI
ALL'ACQUA,
ALLA SUA PUREZZA
E TRASPARENZA,
ALLA SUA ENERGIA DA
CIRCONDARE CON IL
RIGORE DELLA FORMA.
UNA GEOMETRIA CHE
VISUALIZZA IL FASCINO
DEL CRISTALLO E LA SUA
PRESENZA FORTE,
MA DALL'ASPETTO
IMMATERIALE.**

**INSPIRED BY WATER,
LUCENCY AND WHITENESS,
WATER ENERGY
IS SURROUNDED BY SHAPES,
TO AMPLIFY GLASS
BEAUTYNESS.**



COLLEZIONI

Collection

8 WELLNESS

16	Hamam	106	Bagno Turco Professional
18	Ethos	120	Sv steam esterno
34	Ethos C	122	Sv steam semi-incasso
40	Ghibli	134	Bagno Turco Professional
54	Ghibli sauna	140	Generatori Rigenera 200-100-70
56	Saune	162	Chiusura Gemini
66	Cuna Doccia		
74	Cuna		
86	Talia		
94	Kyra		

172 HYDROMASSAGE

176 MINIPISCINE

Mini pool

182	Dream
184	Country
185	Sun
185	Avenue

186 BOX DOCCIA MULTIFUNZIONE

Multifunctions shower cabins

192	Talos Plus
200	Tempo curvo
204	Tempo
210	Soul
216	Sound
222	New Bi-Size

244 COLONNE DOCCIA

Shower column

246	Linea Lama: Lama Metallo / Lama Alulife® / Lama Acciaio / Lama Corian®
254	Plane
258	Brill Plus
260	Light / Light Plus
262	Bridge Plus
264	Linea Etoile
270	Rigenera 200
272	Quarantacinque
274	Quarantacinque S

224 BOX A COMPOSIZIONE

Box composition

226	Time scorrevole
232	Time battente
238	Bristol Box

276 PIATTI DOCCIA

Shower trays

278	Forma
294	Pietrafina
298	Corian®
302	Zeroquattro

306 VASCHE IDROMASSAGGIO

Hydromassage tubs

314	Linea Sensual
324	Linea Bolla
348	For All
350	Zaphiro
351	Oasy
352	Linea Mode
360	Linea Era
366	Eva
368	Duo
369	Ondaria
370	Nemesi
371	Gamma
372	Old Time
373	Armony Plus
374	Sinuhè
375	Igloo
376	Ego
377	Diva
378	Linea Nova

386 VASCHE COMBinate

Tubs with box

388	For All Box
392	Era Plus Box / Era Box
396	Duo Box
397	Linea Nova Box

398 VASCHE AD INCASSO

Built-in tubs

400	Bolla Q
400	Bolla
400	Bolla R
400	Igloo
400	Sinuhè
400	Ego
400	Era
400	Diva
401	Nova
401	Armony Plus
401	Zaphiro
401	Oasy
402	Mode
402	Eva
402	Era plus
403	Era
403	Ondaria
403	Duo
403	Nemesi
404	Gamma
405	Nova

IL TUO BENESSERE PERSONALIZZATO

YOUR WELLNESS MADE-TO-MEASURE

Hafro è un progetto in continua evoluzione per darti una grande gamma di soluzioni, modelli e sistemi che portano il benessere in casa tua. Una concezione che unisce l'alta qualità dei materiali, l'attualità del design e le prestazioni elevate alla convenienza, lavorando sull'innovazione e l'efficienza di tutte le fasi produttive. Un orizzonte che rende possibile il sogno di una vera spa personalizzata tra le rilassanti e confortevoli pareti domestiche.

Hafro is a project that's constantly evolving to provide you with a wide range of solutions, models and systems that bring wellness into your home. A concept that unites top quality materials, contemporary design and high performance with convenience, by working on innovation and efficiency in all stages of production. Developments that make the dream of a real personalised spa within the relaxing, comfortable walls of your home come true.

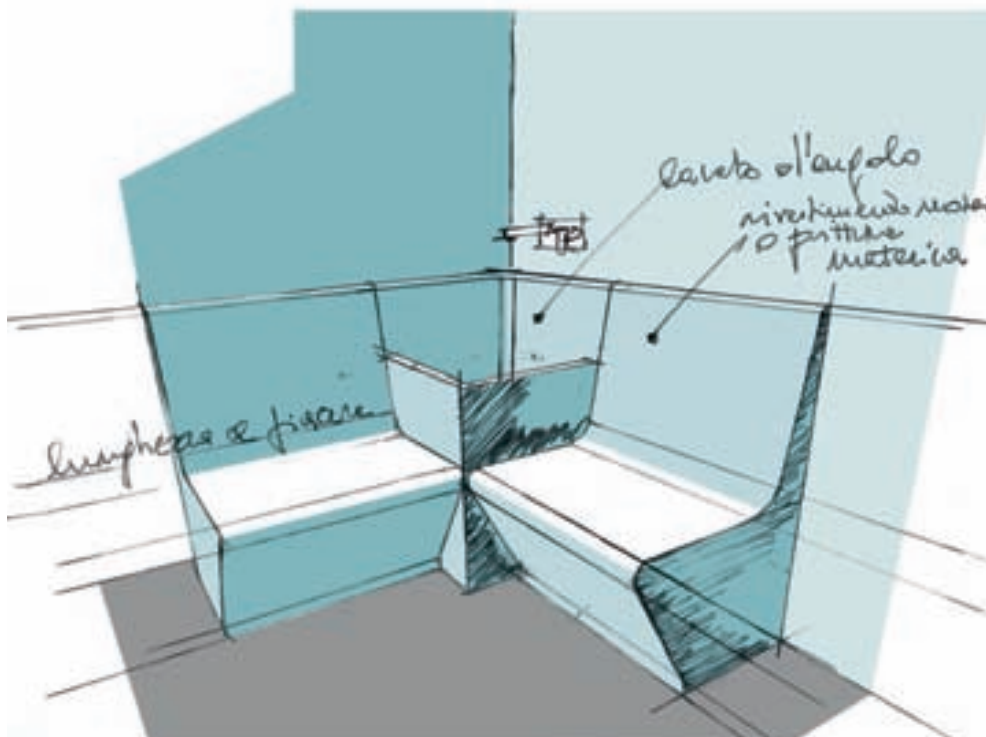
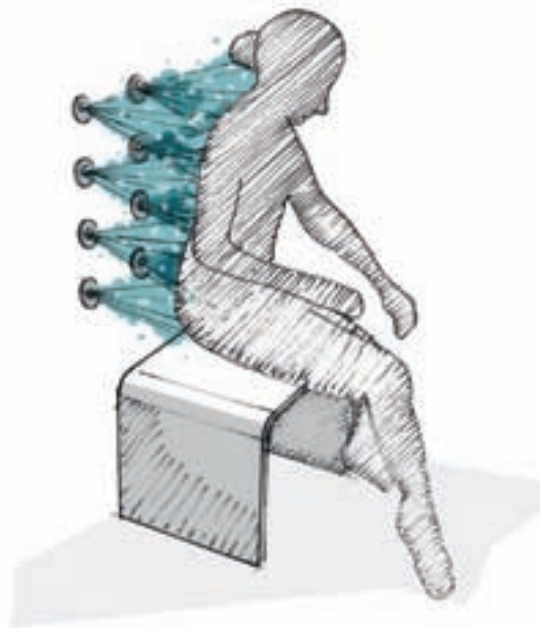

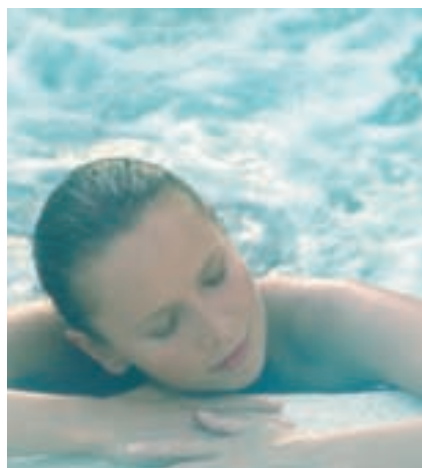
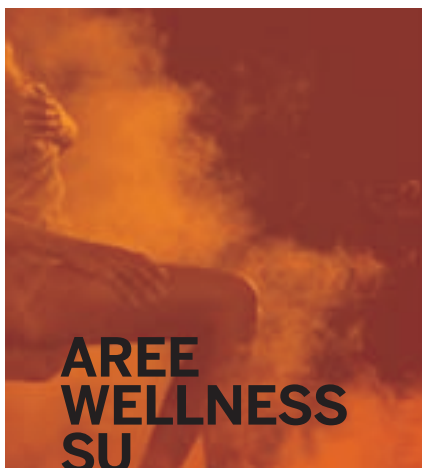

**AREE
WELLNESS
SU
MISURA:
UN'EMO
ZIONE
UNICA
E STRAOR
DINARIA**

Made-to-measure wellness areas:
an extraordinary and unique emotion





INNOVAZIONE WELLNESS DESIGN

INNOVATION WELLNESS DESIGN

A DYNAMIC CONCEPT WITH HIGH QUALITY
SOLUTIONS, MODELS AND SYSTEMS

**UNA
CONCEZIONE
DINAMICA
CON
SOLUZIONI,
MODELLI
E SISTEMI
DI ALTA
QUALITÀ**

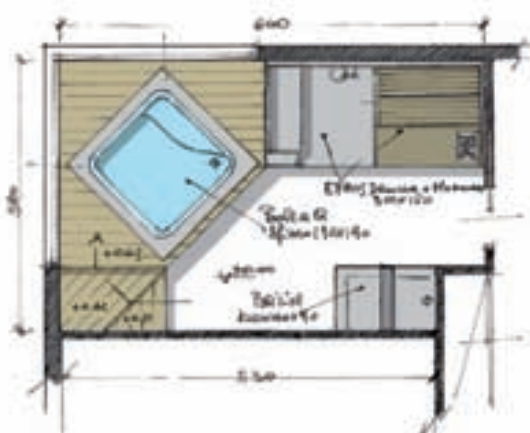

Innovazione continua

Continuous innovation

La ricerca è una modalità del pensiero. Al centro di Hafro c'è la volontà di migliorare continuamente quello che già funziona benissimo, trovando nuove forme e processi che ci portino ogni giorno un passo più avanti. È la miglior garanzia che diamo a chi ci sceglie: avere sempre il frutto più buono di una ricerca che non si ferma.

Research is a way of thinking. At the heart of Hafro there's the desire to continuously improve things that are already working very well, finding new forms and processes that can take us a step further forward every day. It's the best guarantee that we can give to people who choose us: that they will always be provided with the best result from a process of research that never stops.

Wellness a più dimensioni

Multidimensional wellness

La conoscenza di tutto quello che l'acqua e l'aria possono fare per il nostro benessere incontra la ricerca della perfezione tecnologica. Nascono così tutte le forme dell'idromassaggio Hafro, dal programma pulsato al micro diffuso con elettrosoffiante a velocità variabile, ma anche le nuove risorse terapeutiche dei colori, della musica, degli aromi e dell'ozono che le rendono ancora più efficaci.

Knowledge about everything that water and air can do for our wellness meets the search for technological perfection. That is how all Hafro's forms of hydro-massage have been born, from the pulsed program to the micro-diffused massage by electro-blower with adjustable speed but also the new therapeutic resources with colours, music, aromas, and ozone that make them even more effective.

L'evoluzione del design

The evolution of design

Forma e sostanza vanno di pari passo. Hafro segue e spesso anticipa l'evoluzione dell'estetica contemporanea legata all'arredo e agli stili di vita disegnando vasche, box doccia e ambienti secondo le più innovative frontiere del design, portando in casa soluzioni prima esclusive della spa professionali. L'eleganza dà ancora più valore alla funzionalità.

Form and substance go hand in hand. Hafro follows and often foresees developments in contemporary aesthetics linked to interior design and lifestyles, designing bathtubs, shower cubicles and rooms following the most innovative frontiers of design, bringing solutions previously found exclusively in professional spas into the home. Elegance enhances functionality still further.



**AMBIENTI DOVE
PRENDERSI CURA
DI SÉ STESSI
SISTEMI CON PRESTAZIONI
PROFESSIONALI DOVE
VIVERE I BENEFICI
DELL'ACQUA, DEL VAPORE
E DEL CALORE,
IL FASCINO DEI MATERIALI
E LA FUNZIONALITÀ
DELLO SPAZIO**

**SYSTEMS WITH
PROFESSIONAL FEATURES
IN WHICH YOU CAN
EXPERIENCE THE BENEFICIAL
EFFECTS OF WATER, STEAM
AND HEAT, THE APPEAL OF
THE MATERIALS AND THE
PRACTICALITY OF THE SPACE.**

WELLNESS

SPACES IN WHICH YOU CAN CARE FOR YOURSELF

AREA WELLNESS PERSONALIZZATE

CUSTOMIZED WELLNESS ZONE



Il Gruppo Geromin: un mondo che si integra per creare aree wellness perfettamente calibrate sullo spazio reale e sulle esigenze personali di benessere. Le sinergie del Gruppo Geromin permettono infinite ed esclusive possibilità. Ogni stanza da bagno può diventare una vera e propria area wellness coordinando l'inserimento del box doccia e della vasca, scegliendo tra un'ampia gamma di modelli. Nascono così ambienti personalizzati, confortevoli ed eleganti.

Gruppo Geromin is a world active in the creation of wellness zone in every space for every demand. Extraordinary and unlimited solutions. Every room could become a real wellness zone, thanks to shower cabins and bath tubs. There can be created customized, refined and comfortable ambience.

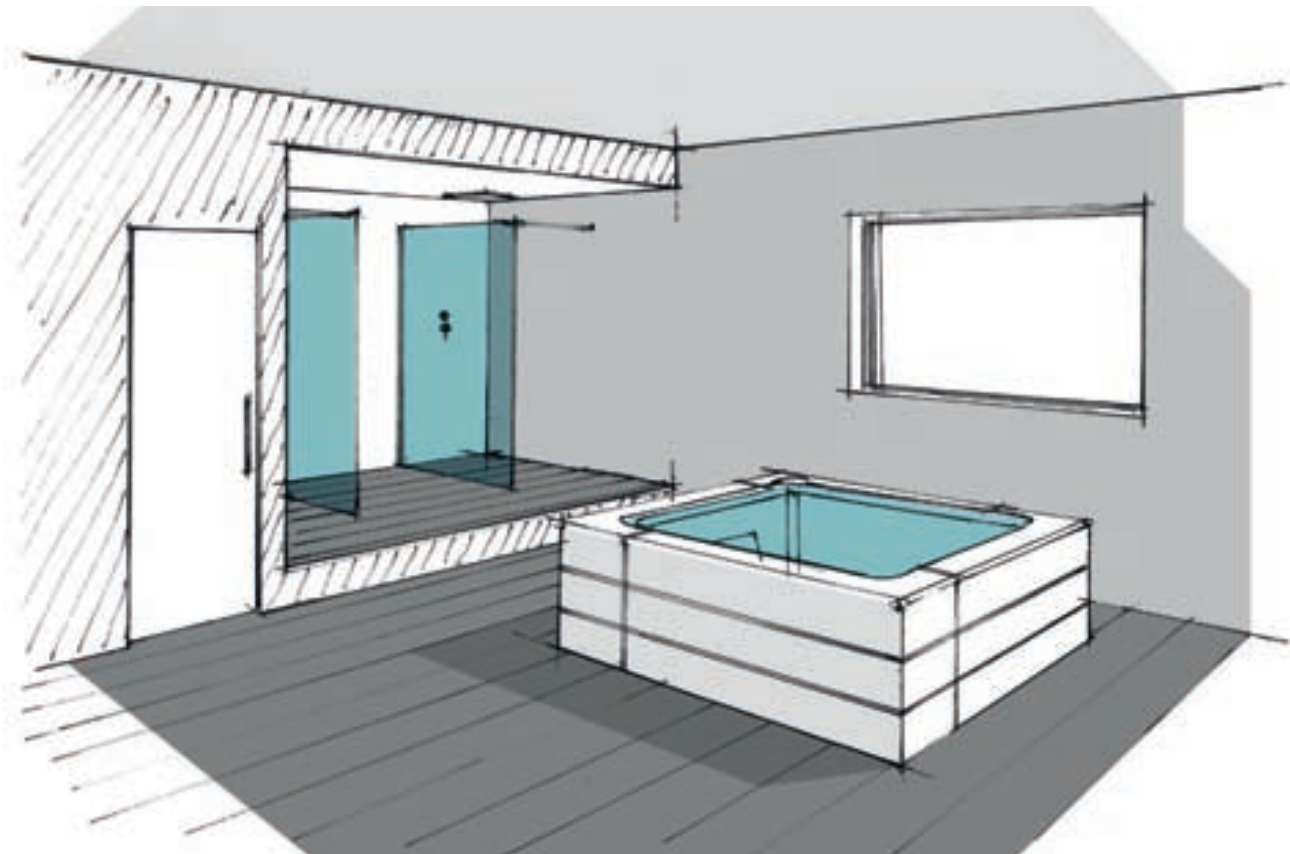
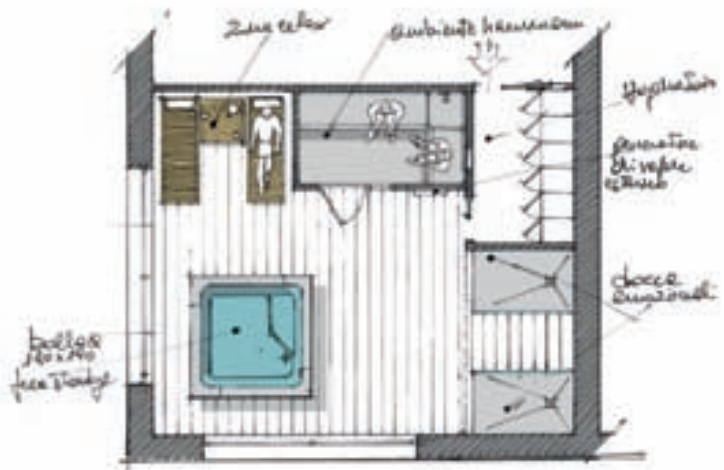

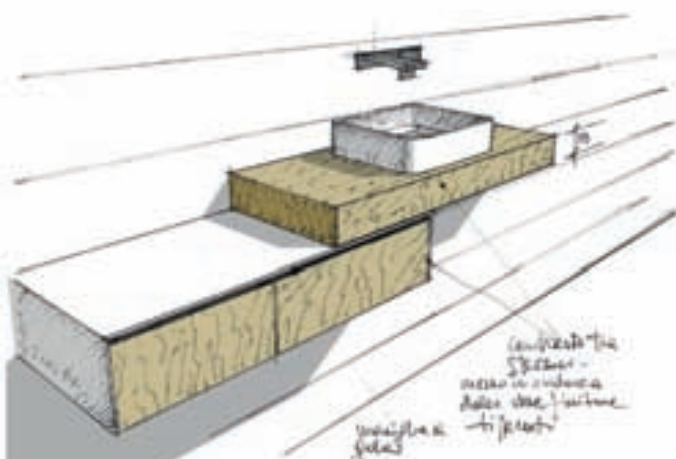

PROGETTI ESCLUSIVI CREATI ATTORNO A TE

Exclusive designs created
around you

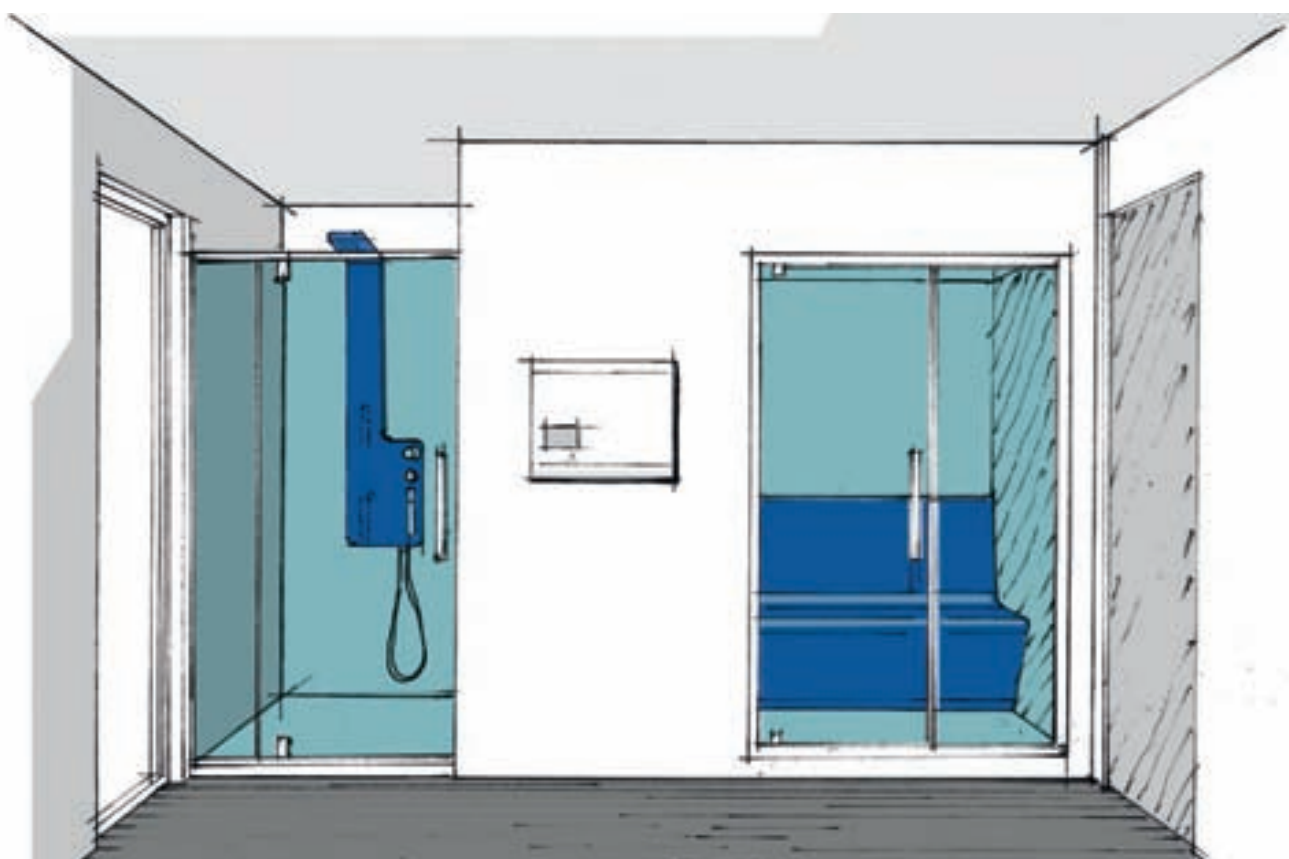

PIENA LIBERTÀ PROGETTUALE

FREEDOM OF PLANNING

La grande gamma di modelli dà una piena libertà di scelta; le possibilità dei materiali e delle finiture consentono di arredare seguendo il proprio gusto; ma soprattutto, la sorprendente varietà delle tecniche wellness permette di creare per ognuno la combinazione migliore.

The wide range of models offers great freedom of choice; the options for materials and finishes mean you can create décor to suit your own taste; but above all the surprising variety of wellness techniques means the perfect combination can be created for each person.

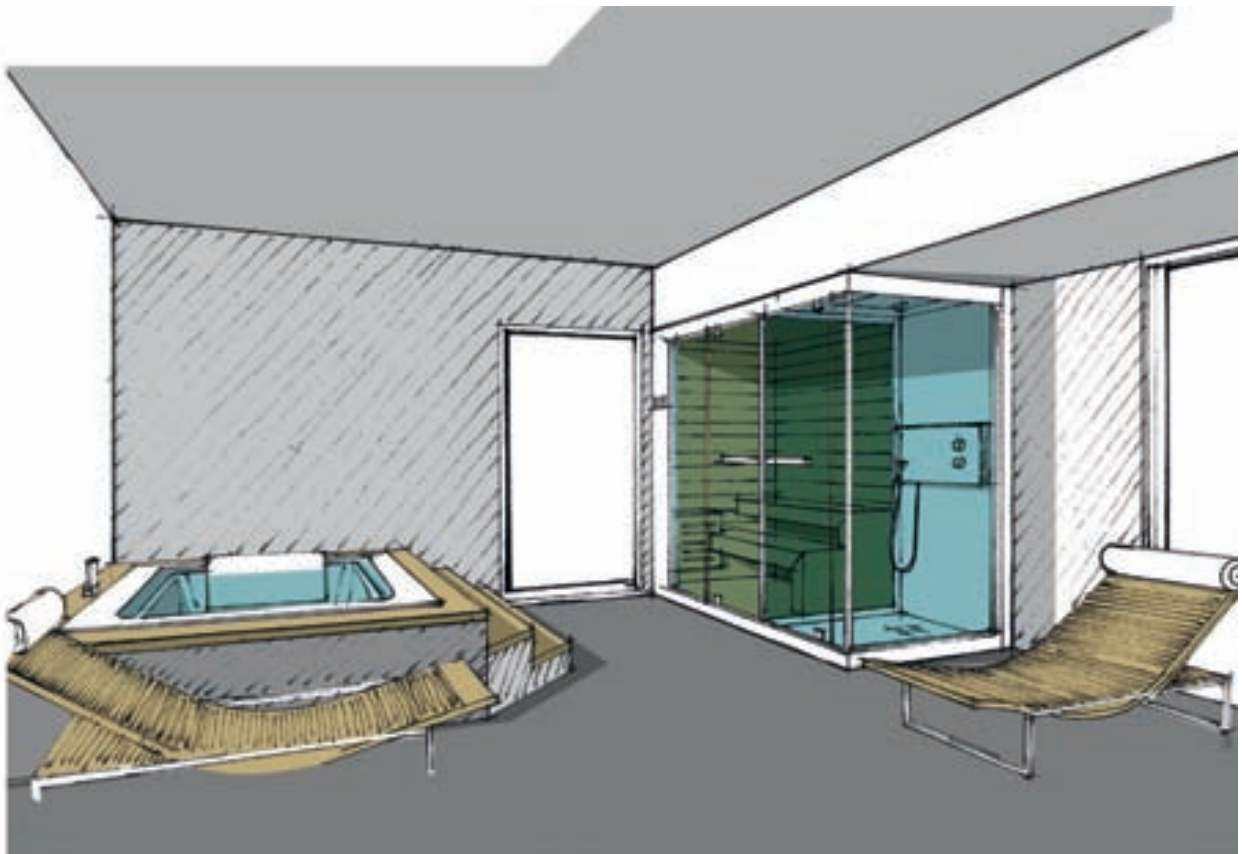
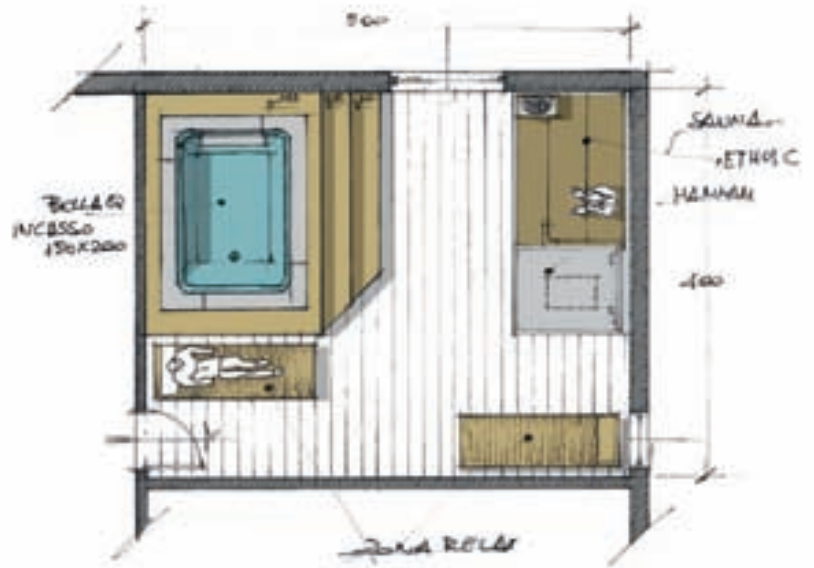

LA VER SABILITÀ DEI PRO GRAMMI APRE SEMPRE NUOVI ORIZZONTI E POSSI BILITÀ

The versatility of the programs opens up more and more new developments and opportunities

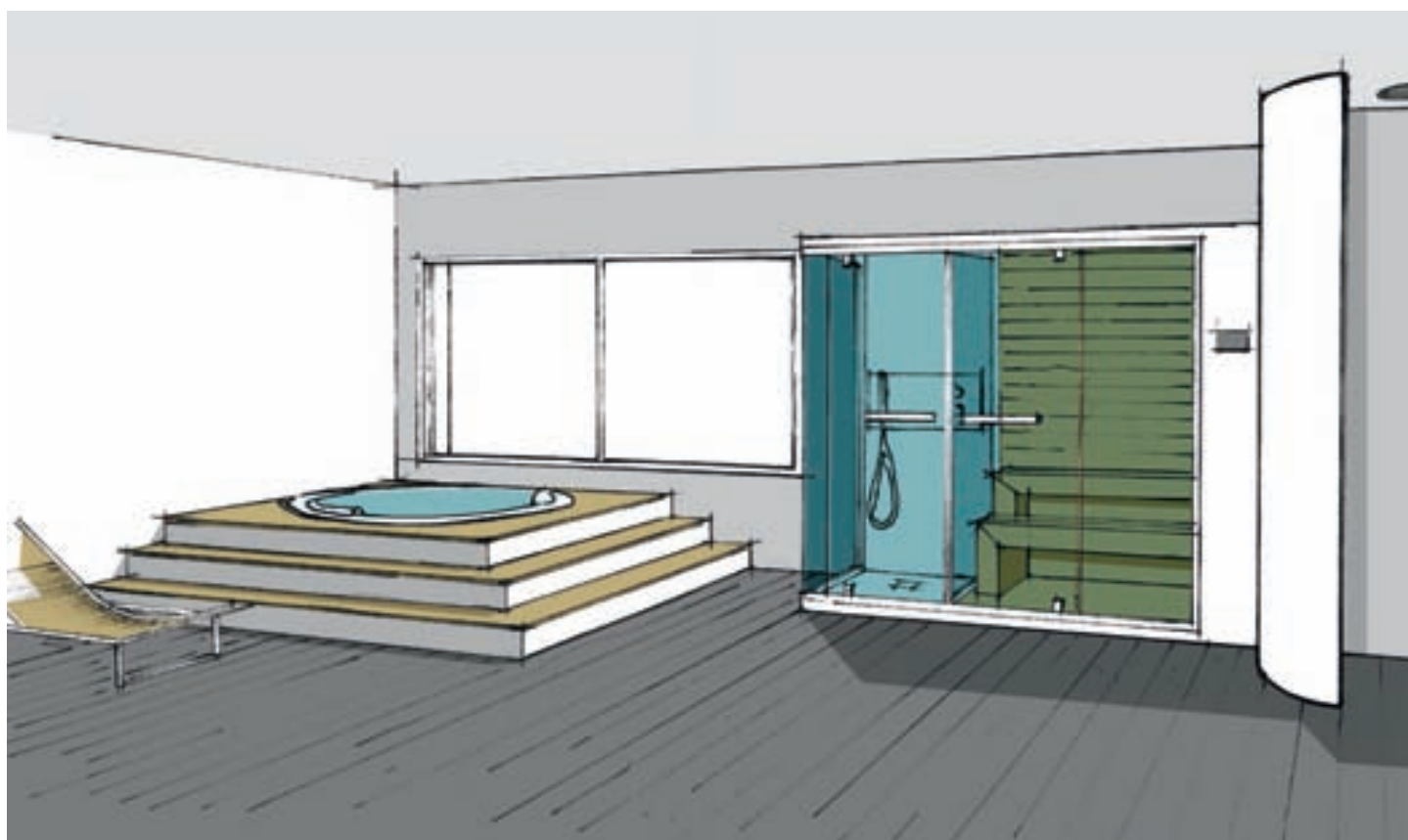
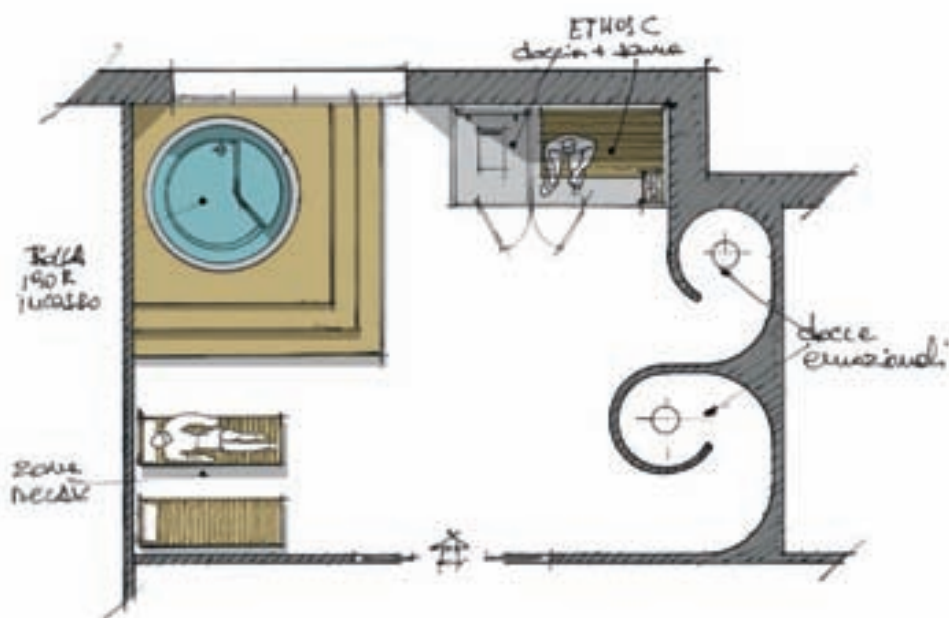



SAUNAVITA®

calore naturale

HAMMAM

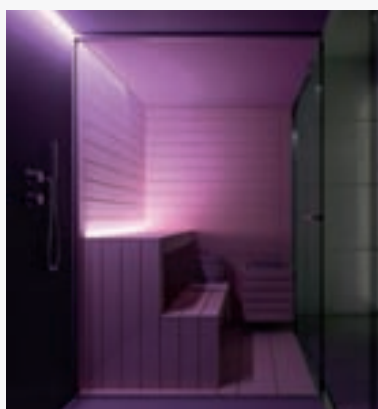

Ethos
Ethos C
Ghibli
Ghibli sauna

SAUNE



Cuna Doccia
Cuna
Talia
Kyra

HAMMAM

HAMMAM

Il vapore che si espande all'interno stimola naturalmente tutto l'organismo agendo sulla circolazione del sangue, sull'eliminazione delle tossine, sulla regolazione nervosa e ormonale di tutti i processi fisiologici. Le sue caratteristiche lo rendono adatto anche alle persone anziane, riducendo gli effetti dell'età e dello stress della vita quotidiana.

Steam whet the entire body, it has effects on flow of blood, on body purification on hormonic system and on nervous system. It is suitable also for aged person, reducing tensions.

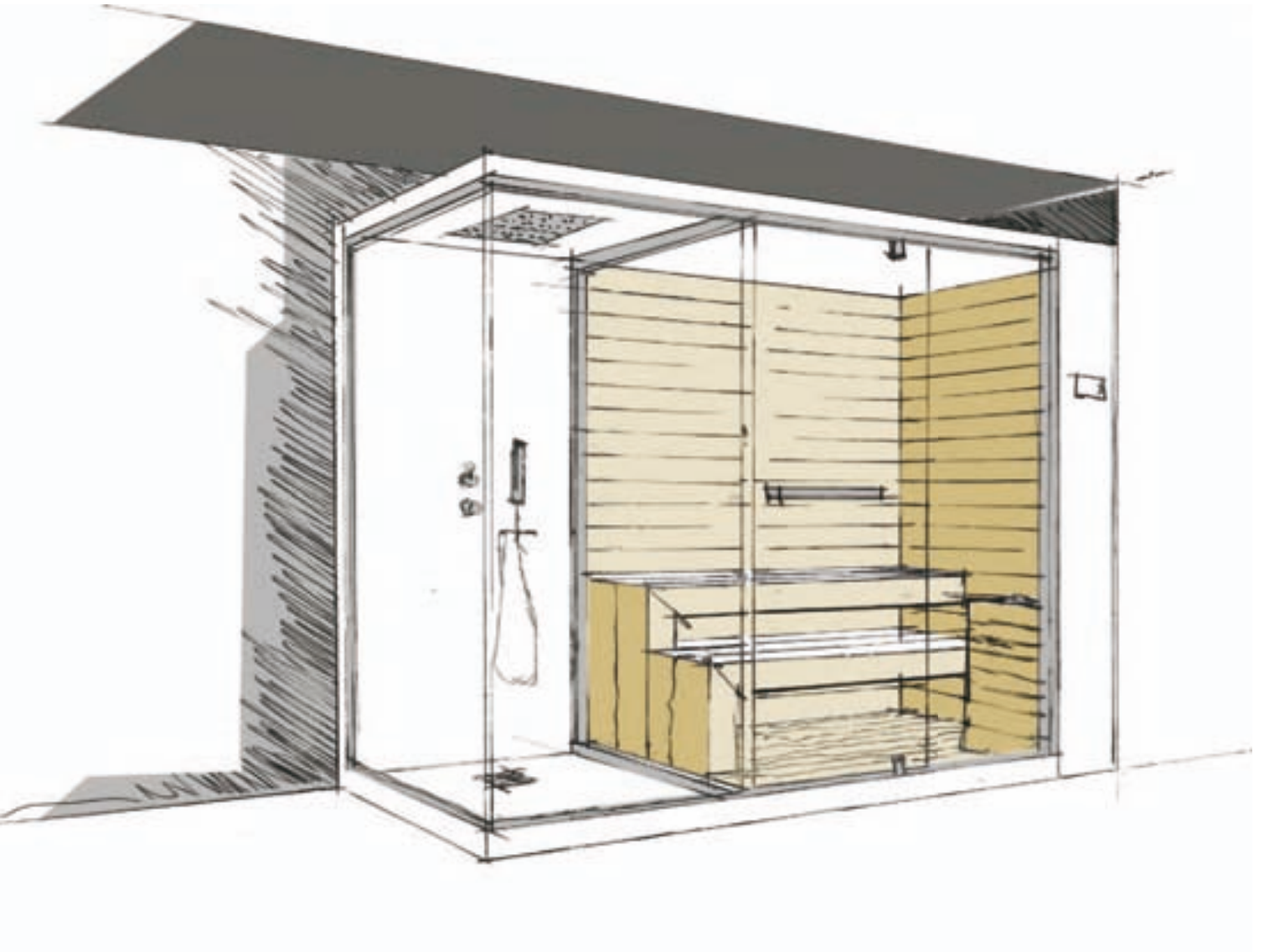



Preparazione / Preparation

Una doccia calda frizionando la pelle con un guanto di crine prepara il corpo all'immersione nel vapore.

A hot shower while massaging your skin with a rough glove prepares your body for being submerged in steam.



Durata / Duration

Rimanere nell'hammam non più di 15 o 20 minuti, seduti o semi sdraiati, rinfrescandosi con spugnature d'acqua.

Stay in the Turkish bath for no more than 15 or 20 minutes, sitting down or semi-reclining, cooling yourself down with spongefuls of water.



Riposo / Rest

Concedersi qualche minuto di riposo usciti da bagno turco, anche con un sonnellino, aumenta gli effetti benefici.

Letting yourself rest for a few minutes when you get out of the Turkish bath, even having a nap, will increase the beneficial effects.

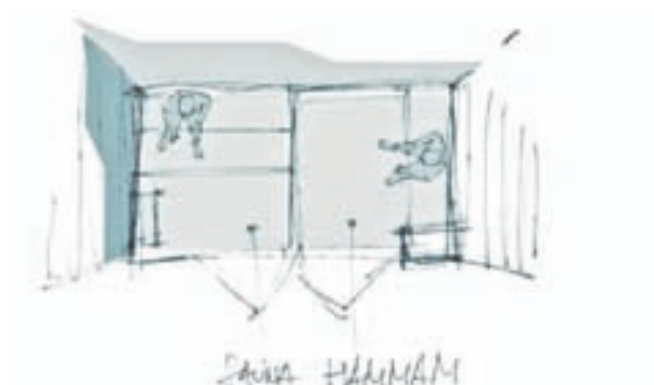



ETHOS

/ Design *Franco Bertoli*

modulo 1

Hamмам con doccia integrata + Sauna

Hamмам with Shower + Sauna

modulo 2

Hamмам + Sauna

Hamмам + Sauna

modulo 3

Spazio Doccia + Sauna

Shower + Sauna

modulo 4

Hamмам + spazio doccia

Hamмам + Shower

modulo 5

Hamмам

Hamмам

Tre moduli per comporre un sistema di wellness integrato funzionale ed accogliente con hammam, spazio doccia e sauna fruibili contemporaneamente da più persone. Ethos crea la soluzione professionale ideale per piccole Spa e strutture ricettive, ma anche per ogni tipo di ambiente domestico.

Three modules to compose a combined wellness system, thank to comfortable Hammam, shower and sauna. Ethos creates the professional solution for small spa and facilities, but also for every kind of household room.

Ethos

Hamman
350 x 150 x 215 h



Hammam con doccia integrata + Sauna

Hamam with Shower + Sauna





Una fonte con l'originale ciotolina in teak per avere sempre a disposizione l'acqua fresca.

A fountain with original teak bowl so that cool water is always available.

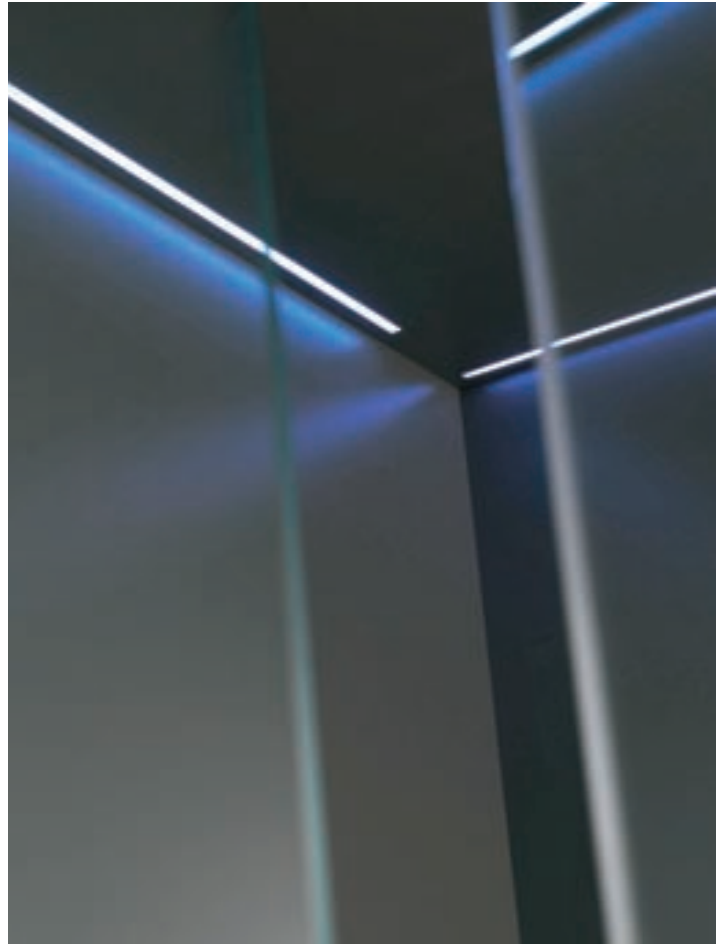

Un sistema di cromoterapia a led permette di immergersi nella benefica influenza dei colori.

A colour therapy system with LEDs lets you immerse yourself in the positive influence of colours.



La comoda apertura a bilico della porta in vetro trasparente o stop sol rende più agevole l'entrata.

The convenient pivoted opening of the clear glass or Stopsol door makes entry more comfortable.



L'allestimento in legno crea un ambiente confortevole, con panche e poggiaschiena double-face.

The wooden fittings create a comfortable environment, with benches and double-face backrest.

Ethos

Hamman
310 x 150 x 215 h



Hammam + Sauna

Hammam + Sauna



Ethos

Hamman
252 x 150 x 215 h



Spazio Doccia + Sauna

Shower + Sauna



Ethos

Hamman
242 x 150 x 215 h



Hamam + Spazio doccia

Hamam + Shower



Ethos

Hamman

VERSATILITÀ DI GAMMA

Versatile selection

La modularità di Ethos consente di comporre il proprio ambiente wellness personalizzato.
The modularity of Ethos let you create your own wellness space.

Hamman con doccia integrata + Spazio doccia + Sauna

Hamman with built in headshower
+ shower space + Sauna

400 x 150 x 215 h

Potenza max: Hamman 4 kW - Sauna 3,6 kW
Dimensioni: Hamman 150 cm - Sauna 160 cm -
Spazio doccia 90 cm

Max power: Hamman 4 kW - Sauna 3,6 kW
Dimensions: Hamman 150 cm - Sauna 160 cm -
Shower space 90 cm



Hamman con doccia integrata + Spazio doccia

Hamman with built in headshower + shower

242 x 150 x 215 h

Potenza max/Max power: 4 kW

Dimensioni/Dimensions:
Hamman 150 cm - Doccia/Shower 92 cm



Hamмам con doccia integrata + Sauna

Hamмам with built in headshower and Sauna

350 x 150 x 215 h

Potenza max/Max power: Hamмам 4 kW - Sauna 4,5 kW
 Dimensioni/Dimensions: Hamмам 150 cm - Sauna 200 cm

350 x 150 x 215 h

Potenza max/Max power: Hamмам 4 kW - Sauna 4,5 kW
 Dimensioni/Dimensions: Hamмам 150 cm - Sauna 200 cm



Sauna + Spazio doccia

Sauna + Shower space

292 x 150 x 215 h

Potenza max/Max power: 4,5 kW
 Dimensioni/Dimensions:
 Sauna 200 cm - Doccia/Shower 92 cm

252 x 150 x 215 h

Potenza max/Max power: 3,6 kW
 Dimensioni/Dimensions:
 Sauna 160 cm - Doccia/Shower 92 cm



Hamмам con doccia integrata

Hamмам with built in headshower

150 x 150 x 215 h

Potenza max/Max power: 4 kW

Dimensioni/Dimensions:
 Hamмам 150 cm



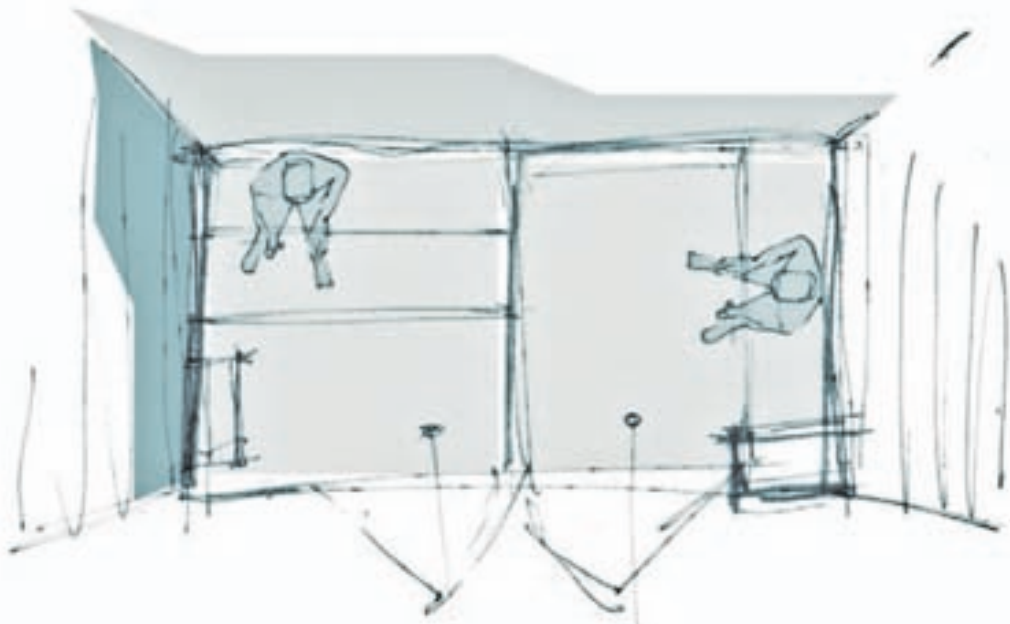

SAUNA HAMMAM

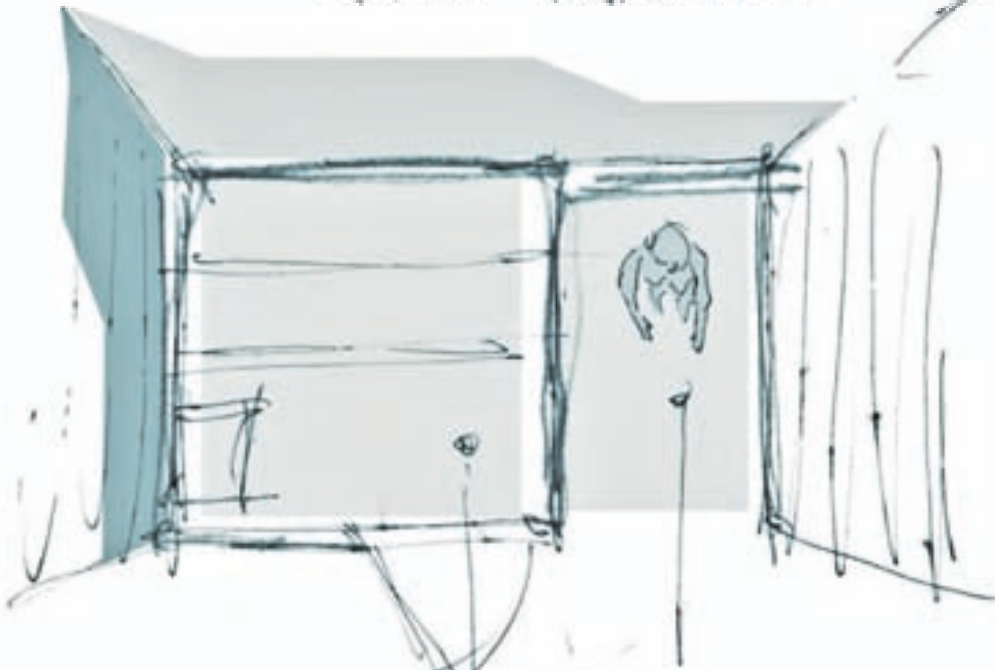

SAUNA FOCCLIS

ALLESTIMENTI ETHOS

Ethos equipment

Finiture

- Esterno: pareti e porte in cristallo temperato
- Interno: Sauna con arredamenti e rivestimenti in abachi; Hammam e Spazio doccia rivestiti in laminato a spessore

Allestimento

- Basamento con piedini regolabili
- Chiusure vetro temperato, spessore 8 mm
- Mensola
- Pannello di controllo (unico per sauna e hammam): pannello touch con finitura in vetro nero serigrafato dotato di display grafico lcd blu retroilluminato a led bianchi; orologio con datario, controllo e gestione tempo e temperatura, preimpostazione di accensione e clessidra elettronica
- Sistema audio: predisposizione radio FM con 8 stazioni memorizzabili; ingresso ausiliario via jack stereo per iPod®/iPad®; 2 casse stereo ausiliarie

Sauna

- Mestolo in legno
- Mastellino in legno
- Stufa con pietre
- Cromoterapia diffusa a led rgb con 3 cicli, cambio colore automatici e funzione iride a 42 colori
- Poggiaschiama double-face

Hammam

- Fonte con ciotolina in teak
- Erogatore di vapore
- Cromoterapia diffusa a led rgb con 3 cicli, cambio colore automatici e funzione iride a 42 colori
- Soffione in acciaio 300x300 (solo nella versione con doccia integrata)

Spazio doccia

- Soffione in acciaio 500x300
- Cascata
- Nebulizzatore
- Doccina
- Cromoterapia diffusa a led rgb con 3 cicli, cambio colore automatici e funzione iride a 42 colori
- Rubinetteria termostatica

Optional

- Poggiaschiama double-face (oltre a quello in dotazione)
- Fianco di tamponamento per installazione ad angolo

Finishing

- External: crystal glass walls and doors
- Inside: Sauna with furnishings and wall schedules in abachi wood; Hammam and Shower room with laminate covering
- Internal: Abachi wood furnishing sauna; laminate covering Hammam and shower

Equipment

- Base with adjustable feet
- Crystal glass enclosures, thickness 8 mm
- Shelf
- Control Panel (for sauna and hammam): touch screen panel made up by black crystal glass with a blue backlight LCD graphic display with white LEDs; clock with date, time and temperature, pre-settable ignition and electronic hourglass
- Sound System: setting up FM radio with 8 presets; auxiliary input via stereo jack for iPod®/iPad®; 2 auxiliary stereo speakers

Sauna

- Wood spoon
- Wood bucket
- Stove with stones
- Chromotherapy diffuse by RGB LED with 3 cycles, Automatic color change and iris feature in 42 colors
- Reversible backrest

Hammam

- Source with teak bowl
- Steam generator
- Colour therapy by RGB LED with 3 cycles, Automatic color change and iris feature in 42 colors
- Head-shower in steel 300x300 (only for hammam with the shower)

Shower space

- Head-shower in steel 500x300
- Cascade
- Nebulizer
- Hand-shower
- Colourtherapy by RGB LED with 3 cycles, Automatic color change and iris feature in 42 colors
- Thermostatic tap

Optional

- Reversible backrest (besides standard equipment)
- Third side for corner installation



ETHOS C

/ Design *Franco Bertoli*

modulo 1

Ethos con sauna+spazio doccia con bagno turco

Sauna + shower space with steam generator

Legni pregiati, materiali tecnologicamente avanzati, soluzioni all'avanguardia. Sauna Vita ridisegna il ruolo della sauna e del bagno turco per gli ambienti domestici ed in quelli professionali, con soluzioni modulari ed integrate. Ethos viene implementato con un modulo sauna affiancato dallo spazio doccia con bagno turco integrato.

Precious wood, innovative materials and advanced solutions. Sauna Vita defines the role of sauna and Turkish Bath both for household use and for accommodation facilities, thanks to modular and integrated solutions. Ethos collection is enriched with a sauna module associated to a shower space with steam generator inside.

Sauna + Spazio doccia con bagno turco

sauna+shower space with steam generator





Ethos C

Hammam
252 x 120 x 214 h



Misure disponibili / Available sizes



x 2/3

252 x 120 x 215 h
Potenza max 5,5 kW



x 3/4

292 x 150 x 215 h
Potenza max 6,1 kW

ALLESTIMENTI ETHOS C

Ethos C equipment

Dimensioni

252x120 cm
(sauna 160x120, doccia con bagno turco 92x120)

292x120 cm
(sauna 200x120, doccia con bagno turco 92x120)

Potenze assorbite

252x120 kW 5,5 (sauna 3 kW, bagno turco 2,5 kW)
292x120 kW 6,1 (sauna 3,6 kW, bagno turco 2,5 kW)

Finiture

Esterno:

Struttura in laminato bianco opaco antigraffio e cristallo temperato da 8 mm con profili in alluminio brillantato.

Interno:

Sauna con arredamento e rivestimenti in Abachi, spazio doccia con bagno turco rivestito in laminato antigraffio bianco opaco.

Allestimento

Basamento con piedini regolabili, maniglie in acciaio, pannello di controllo (sauna e bagno turco) touch screen in vetro serigrafato, sistema audio.

Sauna

Mestolo e mastellino in legno, stufa con pietre, cromoterapia a led rgb 42 colori con cicli, poggia schiena double-face.

Spazio doccia con bagno turco

Soffione in acciaio, cascata, n. 2 nebulizzatori, rubinetteria termostatica con doccia, cromoterapia a led rgb 42 colori con cicli.

Optional

Poggiaschiena double-face (oltre a quello in dotazione)
Fianco di tamponamento per installazione ad angolo.

Dimensions

252x120 cm
(sauna 160x120, shower space with turkish bath)

292x120 cm
(sauna 200x120 shower space with turkish bath 92x120)

Power

252x120 kW 5,5 (sauna 3 kW, Turkish bath 2,5kW)
292x120 kW 6,1 (sauna 3,6 kW, Turkish bath 2,5 kW)

Finishing

External:

Anti scratch matt white finishing laminated and crystal glass 8 mm thick (aluminium profiles).

Internal:

Abachi furnishing sauna. Anti scratch matt white finishing laminated shower space with Turkish bath.

Setting up

Base with adjustable feets, stainless steel handles, touch screen control panel to manage sauna and turkish bath functions, hi fi system.

Sauna

Wooden spoon and bucket, stove with stones, led colour therapy (42 colours Rgb), with automatic colour chance and programmed cycles, double face back-rest.

Shower space with Turkish bath

Stainless steel head shower, vei cascade, n.2 nebulizer, thermostatic tap with hand shower, led colour therapy (42 colours Rgb) with Automatic colour sequence and programmed cycles.

Optional

Double face back rest (in addition to the supplied one)
Insulation panel for corner installation.



GHIBLI

/ Design *Franco Bertoli*

L'HAMMAM DI CASA

Household hammam

Ghibli è un modello di hammam e doccia "chiavi in mano" completo di generatore e struttura coibentante, da installare senza opere di muratura e subito pronto. Con la praticità di un unico interlocutore anche per l'assistenza post vendita, Ghibli semplifica ogni cosa: niente interventi in muratura, niente allestimenti complessi, tempi di attesa e più figure professionali da coordinare.

Ghibli is a turkish model of hammam and shower complete with steam generator and insulating structure, to be installed without masonry work and ready to go. With the convenience of a single point of contact even for after-sales service, Ghibli simplifies everything: no masonry work, no complex preparations, waiting times and more professionals to coordinate.

Ghibli

Hamman
150 x 120 x 215 h





Ghibli

Hamman
150 x 120 x 215 h

Ghibli è il modo più efficace e semplice di beneficiare di un hammam di alta qualità.

Ghibli is the most effective and easy way to enjoy a high quality steam.



Ghibli

Hamman
150 x 120 x 215 h





UN PROGETTO IN TRE MISURE

Three sizes project

Ghibli viene realizzato in tre dimensioni pensate per accogliere una o più persone. Le tre misure facilitano l'inserimento in ogni tipologia di ambiente per soddisfare al meglio le esigenze di spazio, mantenendo inalterate le qualità tecniche ed estetiche.

Ghibli is available in three sizes designed to accommodate one or more persons. The three dimensions facilitate the inclusion in any type of setting to match the needs of space at the best, while maintaining the technical and aesthetic qualities.

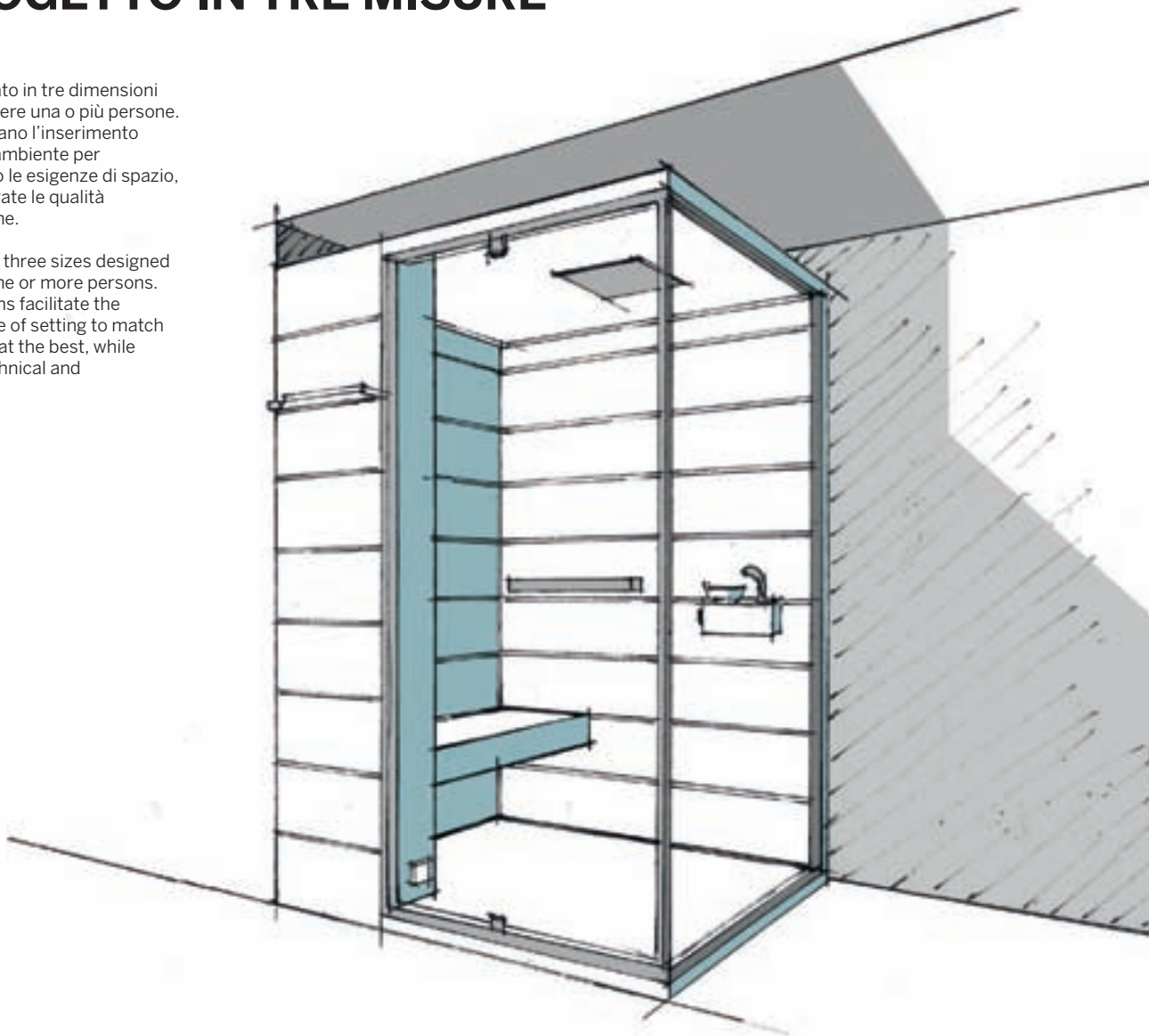

Misure disponibili / Available sizes



x 1

150 x 90 x 215 h
Potenza max 2,7 kW

SX - Left



x 2/3

150 x 120 x 215 h
Potenza max 3,1 kW

SX - Left



x 3/4

150 x 150 x 215 h
Potenza max 4,1 kW

SX - Left

ALLESTIMENTI GHIBLI

Ghibli equipment

Finiture

- Pareti in esterno ed interno: solid surface

Finishing

- External and internal walls: solid surface

Allestimento

- Fonte con ciotolina
- Erogatore di vapore
- Mensola
- Porta salviette
- Struttura basamento con piedini regolabili
- Cromoterapia diffusa a led rgb con 3 cicli, cambio colore automatici e funzione iride a 42 colori
- Chiusure vetro temperato, spessore 8 mm
- Soffione in acciaio 300x300
- Miscelatore termostatico
- Pannello di controllo:
pannello touch con finitura in vetro nero serigrafato dotato di display grafico lcd blu retroilluminato a led bianchi; orologio con datario, controllo e gestione tempo e temperatura, preimpostazione di accensione e clessidra elettronica
- Sistema audio:
predisposizione radio FM con 8 stazioni memorizzabili; ingresso ausiliario via jack stereo per iPod®/iPad®

Setting up

- Source with bowl
- Steam dispenser
- Shelf
- Towel holder
- Base structure with adjustable feet
- Colour therapy diffused by RGB LED with 3 cycles, automatic color change, and iris feature in 42 colors
- Crystal glass enclosure 8 mm thick
- Head shower 300x300 mm
- Thermostatic tap
- Control Panel:
touch screen panel made up by black crystal glass with a blue backlight LCD graphic display with white LED; clock with date, time and temperature, pre-settable ignition and electronic hourglass
- Sound System:
FM Radio ready with 8 presets; auxiliary via stereo jack for iPod®/iPad®



GHIBLI SAUNA

/ Design *Franco Bertoli*

Una gamma che cresce per essere sempre più versatile,
per dare più libertà di scelta e soluzioni per ogni esigenza.

Selection is improved, it becomes wider and wider,
to reach the best in wellness.

Ghibli Sauna

Sauna
150 x 120 x 215 h

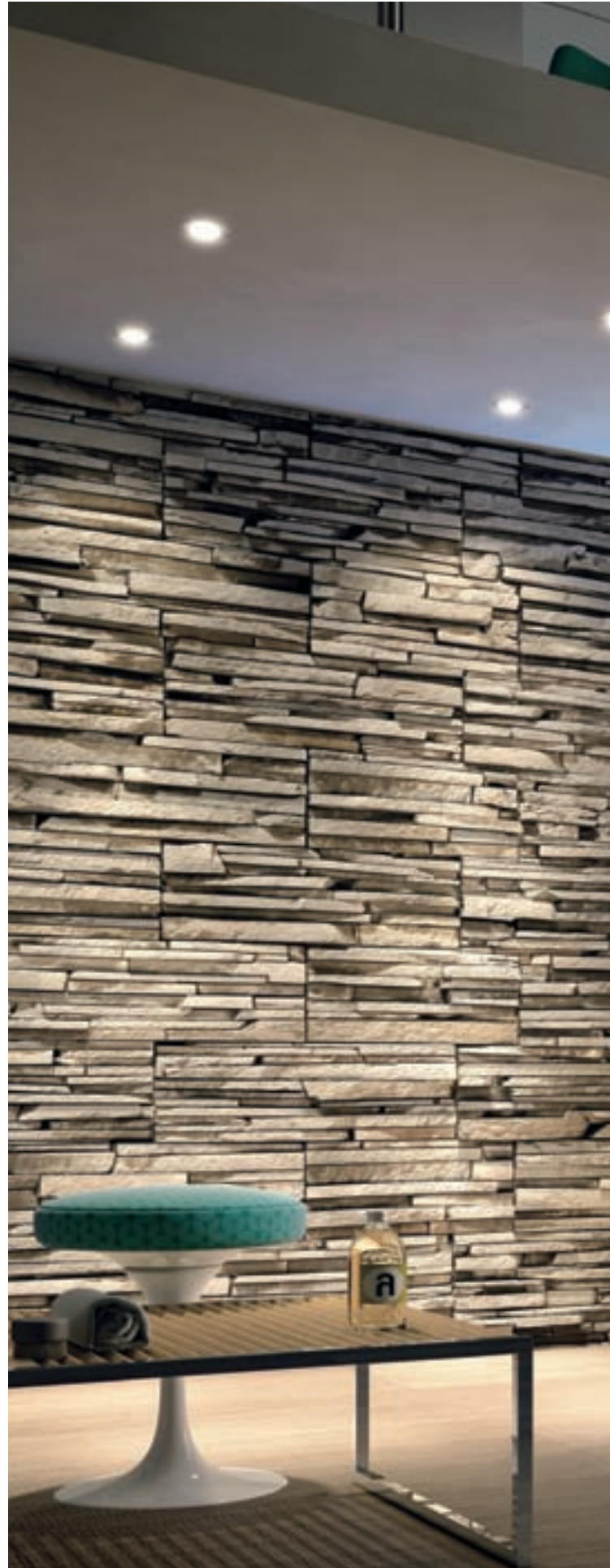



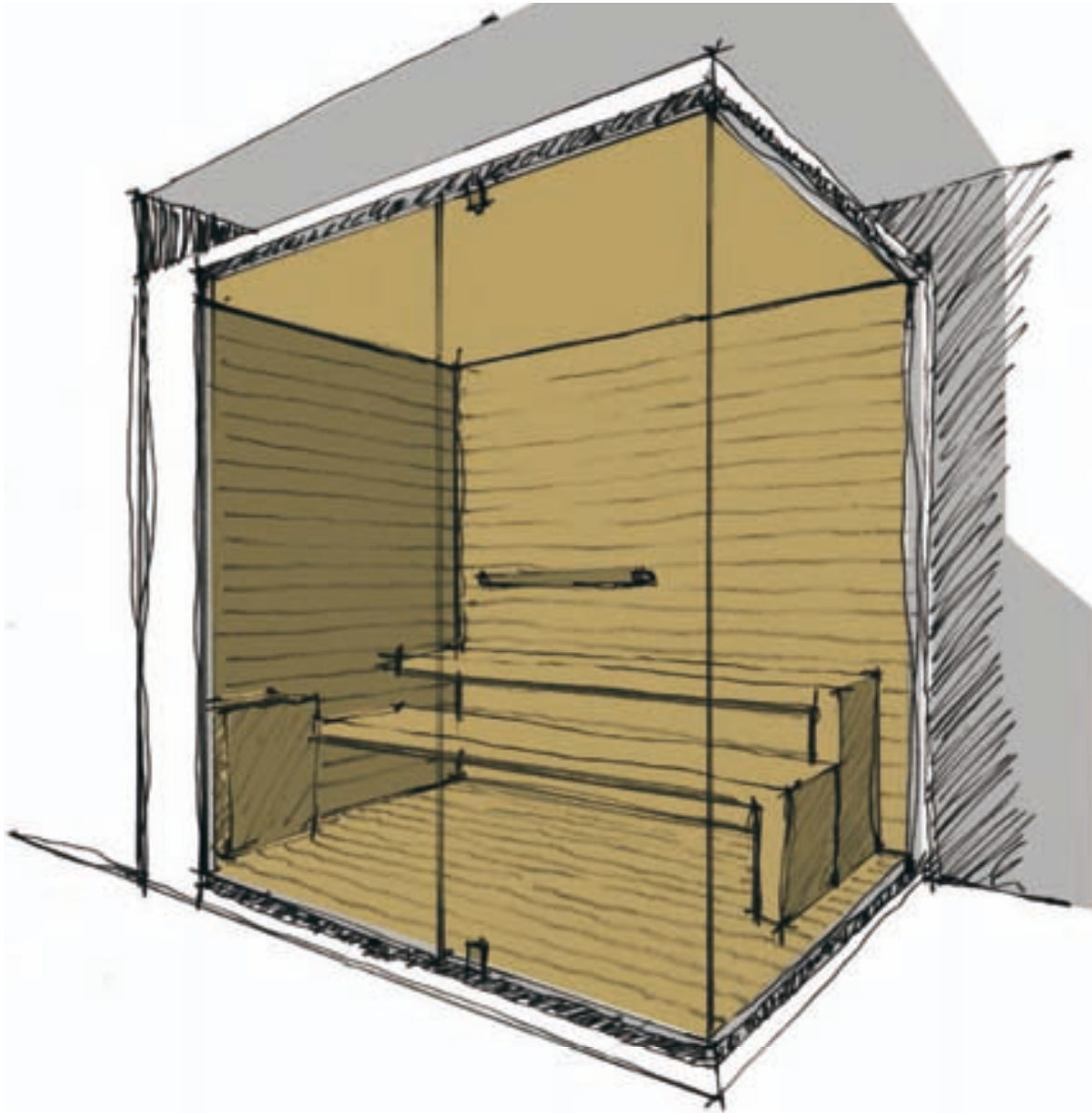

Misure disponibili / Available sizes



x 2/3

150 x 120 x 215 h
Potenza max 3,6 kW



x 3/4

200 x 150 x 215 h
Potenza max 4,5 kW

ALLESTIMENTI GHIBLI SAUNA

Ghibli sauna equipment

Finiture

- Esterno: cristallo temperato
- Interno: abachi

Allestimento

- Basamento con piedini regolabili
- Chiusure vetro temperato, spessore 8 mm
- Pannello di controllo:
- Pannello touch con finitura in vetro nero serigrafato dotato di display grafico lcd blu retroilluminato a led bianchi.
- Orologio con datario, controllo e gestione tempo e temperatura, preimpostazione di accensione e clessidra elettronica
- Sistema audio:
- Predisposizione radio FM con 8 stazioni memorizzabili
- Ingresso ausiliario via jack stereo per iPod®
- Mestolo in legno
- Mastellino in legno
- Stufa con pietre
- Cromoterapia diffusa a led rgb con 3 cicli, cambio colore automatici e funzione iride a 42 colori
- Poggiaschiena double-face

Finishing

- Exterior: tempered glass
- Interior: Abachi wood

Setting up

- Base with adjustable feet
- Tempered glass catches, 8 mm thick
- Control panel:
- Touch screen panel finished in silk-screen printed black glass with a backlit blue LCD graphic display with white LEDs.
- Clock with calendar, time and temperature control and management, switch-on presetting and electronic timer
- Audio system:
- Set up for FM radio with 8 storable stations
- Auxiliary input via stereo jack for iPod®
- Wooden ladle
- Small wooden tub
- Stove with rocks
- Colour therapy using RGB LED lights with 3 cycles, automatic colour change and 42-colour rainbow function
- Double-face backrest



Realizzazioni anche su misura
Can be custom-made.

SAUNE

SAUNE

Gli straordinari benefici della sauna finlandese sono assicurati dall'abbondante traspirazione della pelle dovuta all'elevata temperatura, con un'umidità che dopo aver versato l'acqua sulle pietre varia dal 10 al 20%.

L'alternarsi della sauna alla doccia fredda regala una vitalità senza paragoni.

Il vapore che si espande all'interno stimola naturalmente tutto l'organismo agendo sulla circolazione del sangue, sull'eliminazione delle tossine, sulla regolazione nervosa e ormonale di tutti i processi fisiologici.

Le sue caratteristiche lo rendono adatto anche alle persone anziane, riducendo gli effetti dell'età e dello stress della vita quotidiana.

The extraordinary benefits of the Finnish sauna are guaranteed by the rich perspiration of the skin thanks to high temperature, with the humidity that varies from 10 to 20%. The alternation of sauna and cold shower gives no comparison vigour. Steam whet the entire body, it has effects on flow of blood, on body purification on hormonal system and on nervous system. It is suitable also for aged person, reducing tensions.

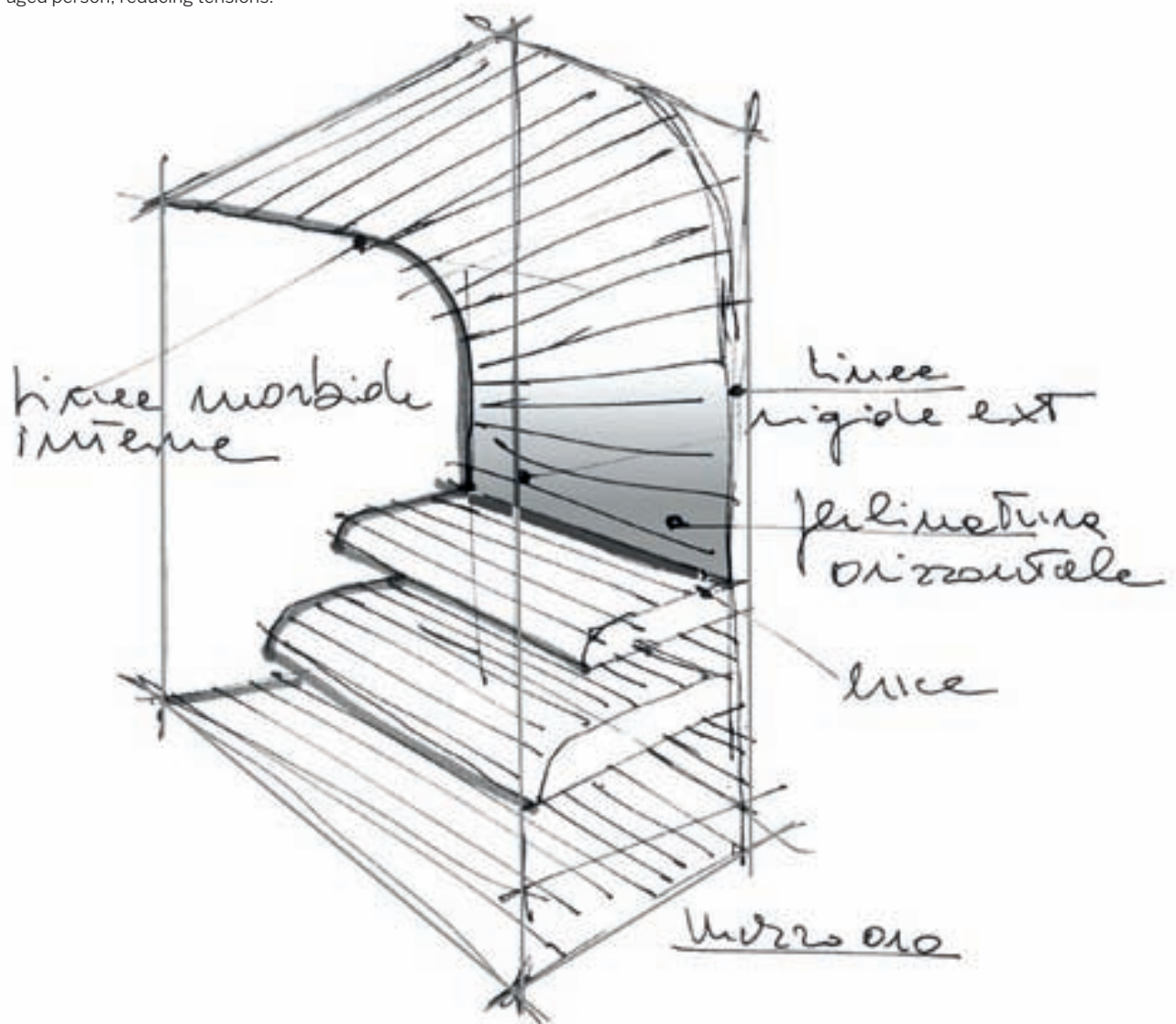



GLI AMBIENTI IDEALI PER IL BAGNO DI CALO RE

Ideal spaces for the hot tub

Secondo la tradizione nordica le saune devono essere costruite in legno, un materiale che continua a vivere anche dopo l'abbattimento della pianta, adatto alla conservazione e propagazione del calore. A queste eccellenze, Sauna Vita® aggiunge le proprietà straordinarie di un legno pregiatissimo finora riservato alla creazione di violini e pianoforti: **l'abete rosso di risonanza della foresta di Tarvisio**, famoso nel mondo per la sua peculiarità nel propagare il suono. Nella realizzazione delle saune, all'abete rosso si affianca l'Hemlock proveniente dalle foreste pluviali dell'Alaska e del Canada occidentale. Una sapiente mescolanza di legni per assicurare alla sauna la massima qualità. Sauna Vita® crea un dialogo tra le vibrazioni naturali del nostro corpo e le vibrazioni sonore del legno, così da sentirsi cullati e coccolati in un ambiente armonico dove parole ed emozioni si propagano in un'atmosfera di puro piacere.

According to the northern tradition saunas have to be build in wood, material that keeps on living even after the tree felling, suitable for the maintenance and propagation of heat. To these excellences, Sauna Vita® adds the extraordinary properties of a rear wood which was devoted to the creation of violins and pianos till now: **the resonance red fir of Tarvisio forest**, famous in the world for its peculiarity in to propagate the sound. In the realization of the saunas, red fir is combined with Hemlock arriving from the rainforests of Alaska and western Canada. A wise woods mixture to assure the maximum quality to the sauna. Sauna Vita® creates a dialogue between the natural vibrations of our body and the sonorous vibrations of the wood, so that we feel cradled and cuddled in a harmonic environment where words and emotions are propagated in an atmosphere of pure pleasure.

RITORNARE ALLA NATURA

Back to nature

La natura possiede infinite risorse per riequilibrare la nostra vita, segreti antichi capaci di donarci un benessere profondo e duraturo. Principi e sensazioni, pratiche e accorgimenti che annullano l'effetto dei ritmi frenetici e dello stress restituendo serenità e armonia al corpo e alla mente. Nella natura possiamo ritrovare noi stessi.

Con Sauna Vita® è come se entrassimo nel caldo abbraccio di un albero, nel tronco cavo di una rara e profumata conifera, mite e rassicurante, dove poter riassaporare tutto il calore naturale della vita. Il corpo dovrebbe essere nutrito anche attraverso la cura dello spirito, con la consapevolezza della sostenibilità delle risorse e di una tecnologia mai invasiva. L'ecologia dell'anima ci fa sentire parte integrante della natura.

Nature holds endless resources to re-balance our life and ancient secrets able to give us a deep and lasting comfort. Principles and feelings, practices and devices that erase bad result of stressful living bringing back serenity and harmony to the body and the mind. In nature we can find ourselves again.

Sauna Vita® make us enter in the warm embrace of a tree, in the hollow trunk of a rare and perfumed conifer, mild and reassuring, whether where to taste the whole natural heat of the life. Body should be also developed through care of spirit, with the awareness of the sustainability of the resources and a never aggressive technology. Ecology of soul makes us to feel essential part of the nature.





DIMENSIONI DOMESTICHE

HOUSEHOLD SIZE

Grazie alle innovazioni del design dovute alla filosofia Sauna Vita®, saune e hammam non richiedono più dispendiosi locali realizzati appositamente, ma si inseriscono perfettamente e facilmente nel bagni e nei locali di servizio della casa.

Thanks to innovations in design due to the philosophy of Sauna Vita®, saunas and steam rooms do not require expensive specially made room, but they perfectly and easily fit in the bathrooms and utility rooms in any house.



La planimetria indica il tipico spazio bagno stretto e lungo, cm 470x170, accessoriato di vasca, lavabo, vaso e bidet. L'intervento proposto ricava uno svicolo tra una camera e il bagno spostando la porta di accesso e inserendo una Sauna Vita Cuna Doccia 200x92 a completamento di un piano con doppio lavabo, mentre vaso e bidet vengono sistemati in un angolo separato.

The plant shows out the typical narrow and long bath space, cm 470x170, provided with tub, sink, WC bowl and bidet. The proposed intervention draws a release between a bedroom and the bathroom moving the entry door and inserting a Sauna Life Cuna Doccia 200x92 to complete a base with double sink, while WC bowl and bidet are positioned in a separate corner.

Prima

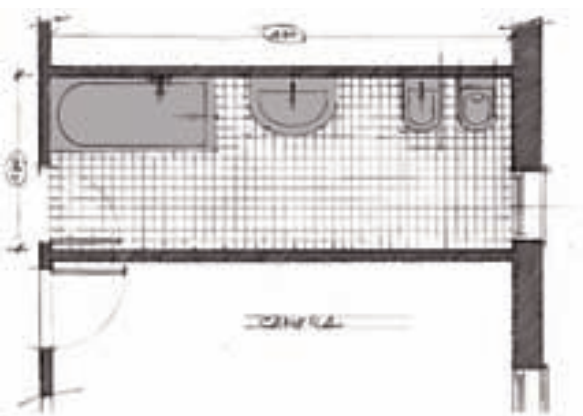

Dopo

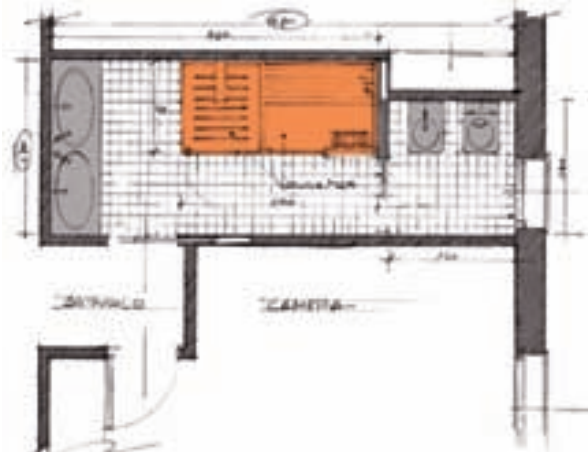

LA VERSATILITÀ DI PROGETTI DINAMICI

The versatility of dynamic designs

Le due planimetrie definiscono l'intervento murario che può essere realizzato all'interno di uno spazio bagno di cm 350x175 confinante con una camera da letto. All'interno del bagno si ricava una nicchia-lavabo della stessa profondità di uno spazio armadio destinato alla camera.

Al posto della vasca si installa una Sauna Vita Cuna Doccia 200x92, lasciando vaso e bidet inalterati nella loro posizione. Il risultato appare compatto e arricchito nelle funzioni.

The two plants define the building intervention that can be realized inside a bath space of 350x175 cm bordering with a bedroom. Inside the bathroom a niche-sink of the same depth of a wardrobe space destined to the bedroom is drawn. Instead of the bathtub a Sauna Vita Cuna Doccia 200x92 get installed leaving WC bowl and bidet in their original position. The result appears compact and enriched in the functions.



Prima

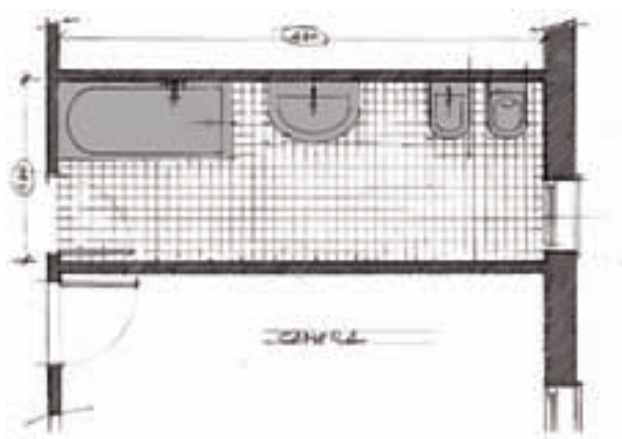

Dopo

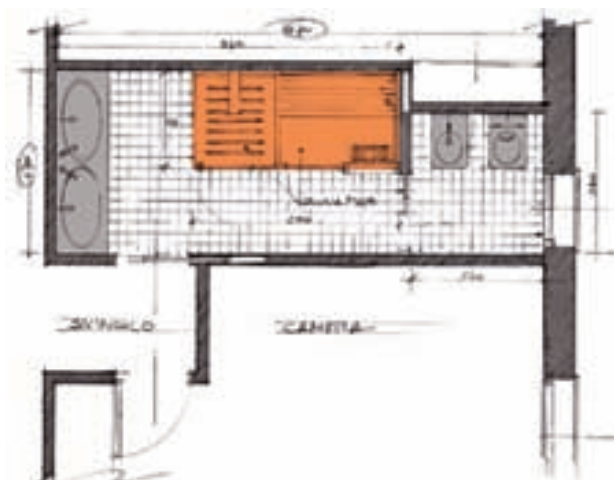

SOLUZIONI CHE OTTIMIZZANO GLI SPAZI

Solutions to make best use of space

Lo spazio bagno quasi quadrato di circa 6 mq contiene un piatto doccia, lavabo, vaso e bidet e una Sauna Vita Cuna 120x127, caratterizzata da un vetro curvo. Tale impostazione favorisce la fluidità dei movimenti all'interno del locale e trova riscontro nei vetri curvi di molte cabine doccia. Lo sketch si riferisce ad una vista di questa soluzione presa dall'angolo vaso.

The almost square bath space for around 6 m² contains a shower tray, sink, WC bowl and bidet and a Sauna Vita Cuna 120x127, characterized by a curved glass. Such formulation favors the fluidity of the movements inside the place and finds comparison in the curved glasses of many shower boxes. The sketch refers to a sight of this solution taken by the WC bowl corner.

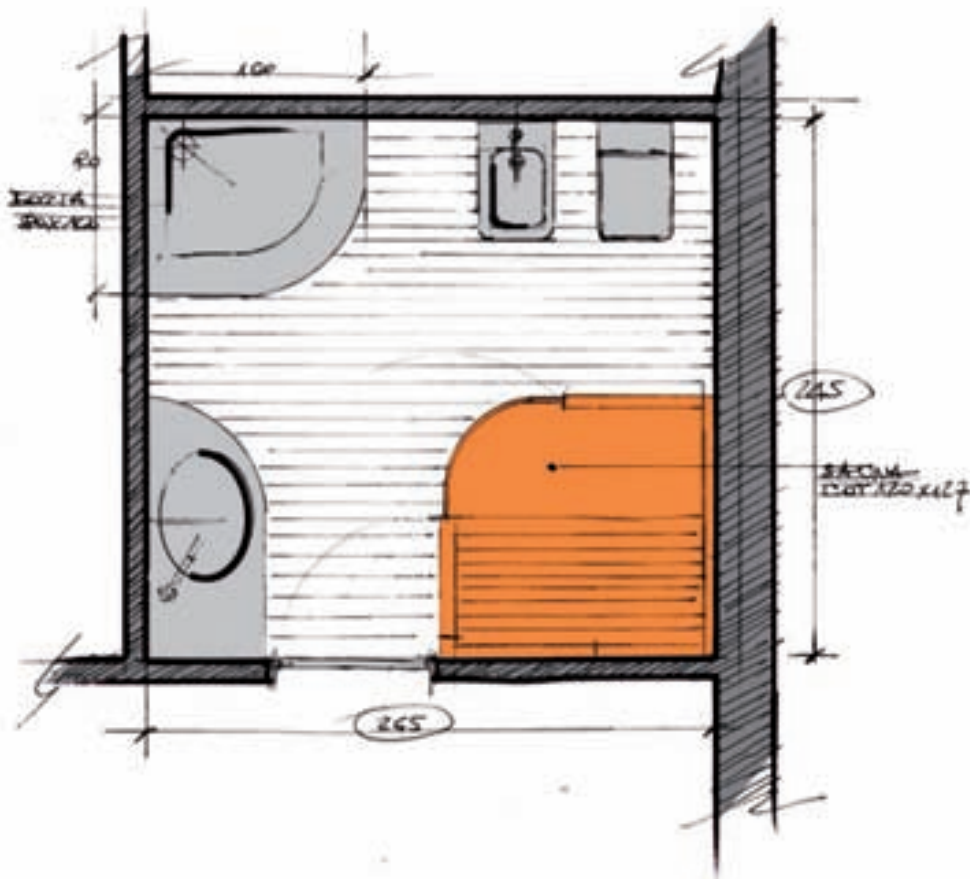

L'esempio sotto riportato prevede uno spazio bagno di circa cm 290x210, nel quale viene inserita una Sauna Vita Cuna Doccia 200x162 a corredo di lavabo, vaso e bidet. Questa soluzione permette di sfruttare al massimo lo spazio disponibile, convogliando verso il centro del locale l'area di utilizzo funzionale.

The following example foresees a bath space of around cm 290x210 where a Sauna Vita Cuna Doccia 200x162 is set in support of sink, WC bowl and bidet. This solution allows to exploit at the best the available space carrying toward the center of the place the functional use area.

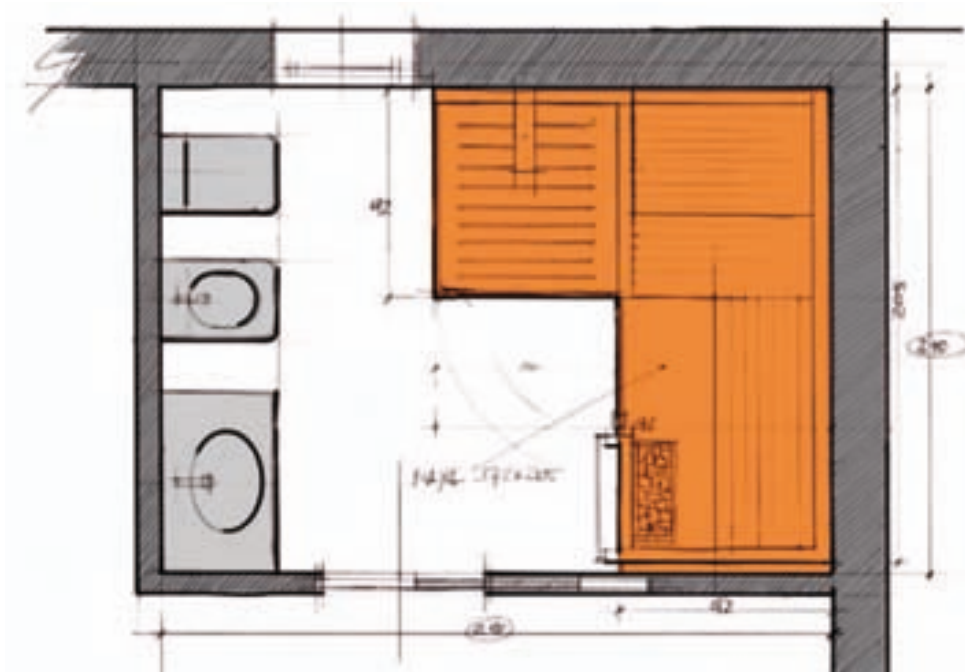
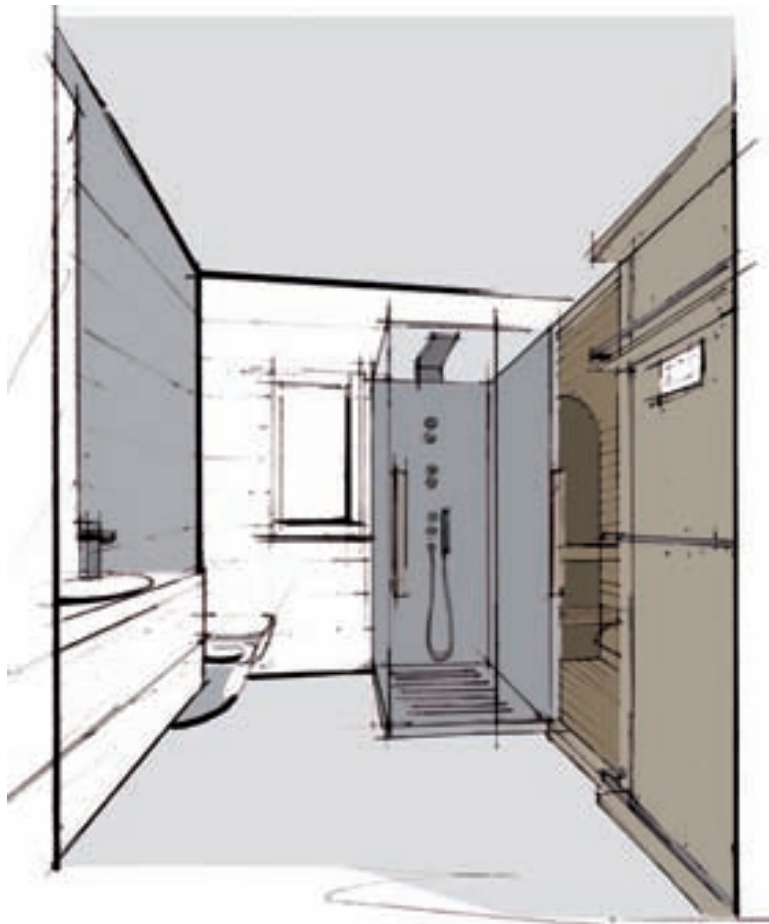







CUNA DOCCIA

/ Design *Franco Bertoli*

Sauna e doccia unite in una pratica combinazione, facilmente inseribile in ogni spazio, per godere dell'antico rito di fuoco e acqua.

Sauna and shower combined in a practical union, easily adaptable in every space, to enjoy some ancient rite of fire and water.

Cuna Doccia

Sauna
150 x 120 x 215 h





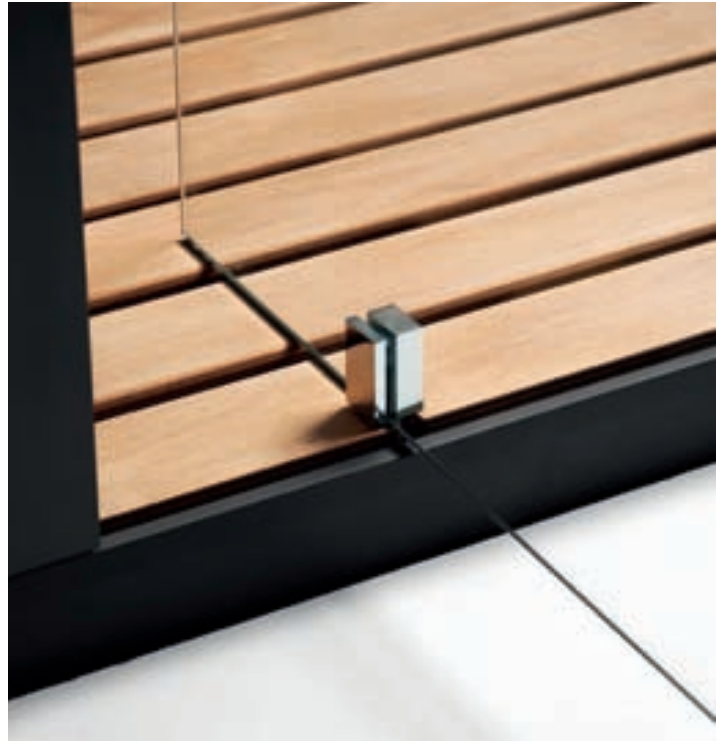

Alla cabina doccia si accede mediante una porta con apertura a bilico e maniglia in legno uguale a quella della sauna.

Enter the shower unit via a pivot door featuring a wood handle matched to the sauna handle.



Box con soffione integrato, rubinetteria termostatica, doccia, 4 jets verticali e pedana in multistrato marino.

Cubicle with integrated hot spray, thermostatic taps, shower head, 4 vertical jets and platform in marine plywood.

Misure disponibili / Available sizes



x 3/4

205 x 207 x 204 h
Potenza max 3,6 kW



x 2/3

205 x 172 x 204 h
Potenza max 2,3 kW



x 1

200 x 92 x 204 h
Potenza max 2,3 kW

ALLESTIMENTI CUNA DOCCIA

Cuna shower equipment

Finiture

- Esterno: Hemlock/Hemlock e pannello frontale in Wengè
- Interno: Hemlock
- Arredamenti: Abachi

Allestimento

Sauna

- Mestolo in legno
- Mastellino in legno
- Mensole
- Porta salviette
- Struttura basamento con piedini regolabili
- Cromoterapia diffusa a led rgb con 3 cicli, cambio colore automatici e funzione iride da 42 colori
- Porta in cristallo temperato, spessore 8 mm
- Stufa con pietre
- Pannello interno con lastra di protezione ultrapiatta Laminam® (finitura bronzo) posizionata dietro la stufa
- Pannello di controllo: Pannello Touch con finitura in vetro nero serigrafato dotato di display grafico lcd blu retroilluminato a led bianchi; orologio con datario, controllo e gestione tempo e temperatura, preimpostazione di accensione e clessidra elettronica

Cabina doccia

- Cabina doccia multifunzione: piatto doccia; pareti attrezzate con rubinetteria termostatica e 4 soffioni verticali; doccia; chiusura con porta battente in cristallo da 8 mm; pedana in legno multistrato marino

Optional

Sauna

- Poggiaschiena double-face
- Vetro Stopsol
- Sistema audio: predisposizione radio FM con 8 stazioni memorizzabili; ingresso ausiliario via jack stereo per iPod®/iPad®; 2 casse stereo ausiliarie

Finishing

- External: Hemlock/Hemlock and Wengè finished front panel
- Internal: Hemlock
- Furniture: Abachi

Equipment

Sauna

- Ladle in wood
- Bucket in wood
- Shelves
- Towels keeper
- Basement structure with adjustable feet
- Diffused colour therapy, RGB leds with 3 cycles, automatic color change and 42 colors iris function
- Tempered crystal glass 8 mm thick enclosure
- Stove with stones
- Inside panel with flat protection plate in Laminam® (bronze finishing) placed behind the heater
- Control panel: Black crystal glass touch screen panel built in wall with blue graphic lcd backlit with white led; clock with date, control and management time and temperature, switch on pre-setting and electronic hourglass.

Shower

- Multi-function shower: Shower tray in LG with footboard made of extractable staves; walls equipped with thermostatic taps and four vertical jets; shower; enclosure with crystal leafed door 8 mm; marine wood footboard

Optional

Sauna

- Additional double-face back rest
- Stopsol glass
- Audio system: predisposition for FM radio with 8 storable channels; auxiliary entry by stereo jack for iPod®/iPad® connection; 2 additional stereo speakers



Realizzazioni anche su misura
Can be custom-made.



CUNA

/ Design *Franco Bertoli*

Linee morbide che valorizzano il senso dell'abbraccio e la leggerezza con un giusto equilibrio tra legno eco-trattato e vetro di altissima qualità.

Soft lines which appraise a sense of the embrace and lightness with a correct equilibrium between eco-treated wood and glass of high quality.

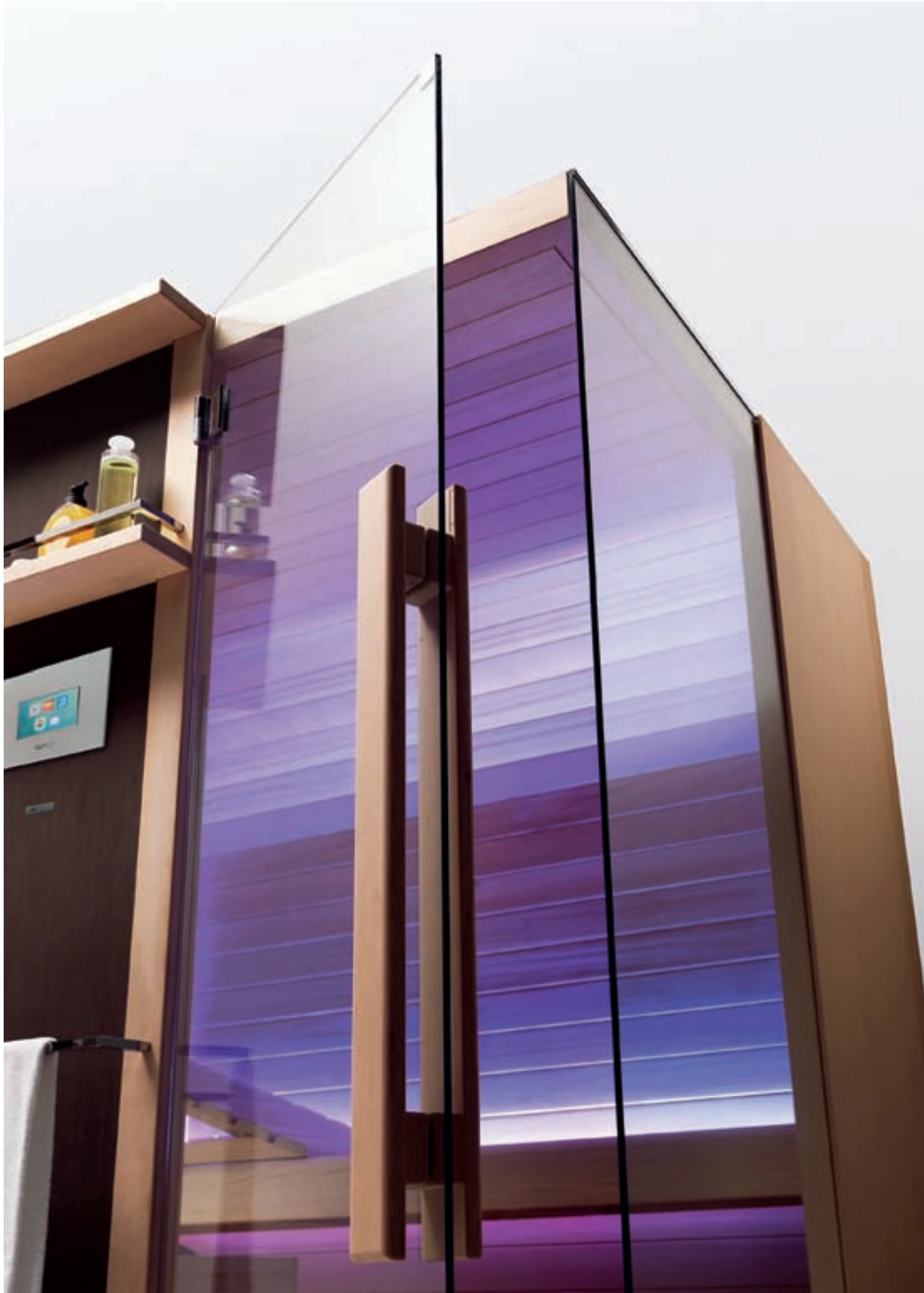

TUTTA LA LUMINOSITÀ DEL VETRO

The whole brightness of the glass

Al legno, che è il materiale per eccellenza della sauna finlandese, la nostra ricerca per una piena soddisfazione di ogni desiderio estetico ci ha condotto a utilizzare il vetro non solo per la realizzazione della porta, ma anche per la struttura stessa. La tipologia ad angolo testimonia la perfezione raggiunta nel dare alla sauna un piacere infinito.

Wood is the main material of finnish sauna and we are always searching for a full satisfaction of aesthetical desire, so we have decided to use glass also in the structure itself. The corner typology testifies the reached perfection in to give an endless pleasure to the sauna.



L'installazione di un sistema di cromoterapia a led permette di immergersi nei colori e nella loro benefica influenza per stimolare gioia, energia e per godersi un meritato relax.

Led colour therapy system allows the immersion in the colors and in their beneficent influence to stimulate joy, energy in order to enjoy the deserved relax.

La musica è passione, è relax, è emozione. Sauna Vita® porta la musica nella sauna con la possibilità di aggiungere un sistema audio formato dalla filodiffusione, dalla radio in FM e dalla predisposizione per l'ingresso iPod®.

Music is passion, relax, emotion. Sauna Vita® brings music into the sauna with the possibility to add a system audio composed by the the radio in FM and from the provision to iPod entry.

La stufa, centro naturale della sauna, è in una posizione assolutamente sicura e può essere separata dalla struttura con un pannello in LAMINAM®, materiale altamente tecnologico che consente una totale protezione dal calore. Il LAMINAM® non ha solo ottime prestazioni tecniche, ma anche un gradevole aspetto che ben si inserisce nell'accurata estetica della sauna.

The heater, natural center of the sauna, is located in a safe place and it's isolated from the framework by a LAMINAM® panel, an highly technological material that allows a total protection from the heat. LAMINAM® doesn't have only good technical performances, but also a pleasant aspect that perfectly match with the accurate aesthetics of the sauna.



x 2/3

Cuna 165 x 127 x 204 h nicchia/niche
Potenza max 3 kW/Max power 3 kW



Cuna 165 V doppia porta 165 x 127 x 204 h
Potenza max 3 kW/Max power 3 kW

IL COMFORT PER UN PERFETTO RELAX

Comfort for a perfect relax

Lo spazio della sauna è studiato per creare un ambiente dove il relax diventa naturale. Comodamente seduti o sdraiati su confortevoli panche di legno dotate di appoggi orientabili, rivolgerete lo sguardo oltre ampie e luminose vetrate che vi daranno un piacevole senso dello spazio. Vivere la sauna sarà un'esperienza meravigliosa.

Sauna's space has been studied to create an environment where relax becomes natural. Comfortably sit or lying down on comforting wood benches equipped with adjustable supports, you will turn the look over ample and bright glass doors and windows that will give you a pleasant sense of the space. Way of living the sauna will be a extraordinary experience.





IL CALORE BUONO: UN SISTEMA INTEGRATO E SICURO

The good heat: an integrated and safe system

All'aspetto esteriore si unisce l'anima vitale della sauna, rappresentata dal calore. La tecnologia Sauna Vita® ha messo a punto un sistema di massima efficienza formato da una caldaia di tre tipologie (con diversa potenza in base alla cubatura della sauna), un pannello digitale di controllo, una sonda di rilevazione dell'umidità e della temperatura.

Heat is essential part of sauna, Sauna Vita® technology has developed a maximum efficiency system formed by a heater of three typologies (with different caloric power according to the cubic volume of the sauna), a digital control panel, a damp and the temperature level sensor.





x 2

Cuna 120 curva 120 x 127 x 204 h
Potenza max 2,3 kW/Max power 2,3 kW

Misure disponibili / Available sizes



 **x 1**
120 x 92 x 204 h
Potenza max 2,3 kW
dx/sx



 **x 2/3**
150 x 127 x 204 h
Potenza max 2,3 kW
dx/sx



 **x 3**
200 x 127 x 204 h
Potenza max 3,6 kW



 **x 1**
120 x 92 x 204 h
Potenza max 2,3 kW
dx/sx



 **x 2**
165 x 92 x 204 h
Potenza max 2,3 kW
dx/sx



 **x 3/4**
200 x 142 x 204 h
Potenza max 4,5 kW



 **x 2**
120 x 127 x 204 h
Potenza max 2,3 kW
dx/sx



 **x 2/3**
165 x 127 x 204 h
Potenza max 3 kW



 **x 2/3**
205 x 92 x 204 h
Potenza max 2,3 kW



 **x 2**
120 x 127 x 204 h
Potenza max 2,3 kW
dx/sx



 **x 2/3**
165 x 127 x 204 h
Potenza max 3 kW



 **x 3**
205 x 127 x 204 h
Potenza max 3,6 kW

ALLESTIMENTI CUNA

Cuna equipment

Finiture

- Esterno: Hemlock/Hemlock e pannello frontale in Wengè
- Interno: Hemlock
- Arredamenti: Abachi

Allestimento

- Mestolo in legno
- Mastellino in legno
- Mensole
- Porta salviette
- Struttura basamento con piedini regolabili
- Cromoterapia diffusa a led rgb con 3 cicli, cambio colore automatici e funzione iride da 42 colori
- Chiusure vetro temperato, spessore 8 mm
- Stufa con pietre
- Poggiaschiena double-face
- Pannello interno con lastra di protezione ultrapiatta Laminam® (finitura bronzo) posizionata dietro la stufa
- Pannello di controllo: pannello touch con finitura in vetro nero serigrafato dotato di display grafico lcd blu retroilluminato a led bianchi; orologio con datario, controllo e gestione tempo e temperatura, preimpostazione di accensione e clessidra elettronica

Optional

Sauna

- Poggiaschiena double-face (oltre a quello in dotazione)
- Vetro Stopsol
- Sistema audio: predisposizione radio FM con 8 stazioni memorizzabili; ingresso ausiliario via jack stereo per iPod®/iPad®; 2 casse stereo ausiliarie

Finishing

- External: Hemlock/Hemlock and Wengè finished front panel
- Internal: Hemlock
- Furniture: Abachi

Equipment

- Ladle in wood
- Bucket in wood
- Shelves
- Towels keeper
- Basement structure with adjustable feet
- Diffused colour therapy, RGB leds with 3 cycles, automatic color change and 42 colors iris function
- Crystal glass 8 mm thick enclosure
- Stove with stones
- Double-face back rest
- Inside panel with flat protection plate in Laminam® (bronze finishing) positioned behind the heater
- Control panel: black crystal glass touch screen panel built in wall; endowed with blue graphic lcd backlit with white led; clock with date, control and management time and temperature, switch on pre-setting and electronic hourglass

Optional

Sauna

- Additional double-face back rest (besides standard equipment)
- Stopsol glass
- Audio system: predisposition for FM radio with 8 storable channels; auxiliary entry by stereo jack for iPod®/iPad® connection; 2 additional stereo speakers



Realizzazioni anche su misura
Can be custom-made.



TALIA

/ Design *Franco Bertoli*

L'essenzialità della linea fa emergere la naturale presenza dell'abete di
risonanza, con eleganza, senso delle proporzioni e stile rigoroso.

The minimalism of the line foreground natural presence
of fir of resonance with elegance, sense of the proportions and rigorous style.

Trasparente ma discreta, luminosa ma elegante. La porta in vetro è indispensabile per la vivibilità dell'ambiente. La finitura stopsol garantisce le condizioni migliori con un'ottima visibilità verso l'esterno ed un parziale oscuramento verso l'interno.

Shine through and discreet, bright and refined. Crystal glass door is essential. Stopsol finishing ensures the best conditions with good visibility to the outside and a partial obscuration inside.





x1

Talia 120 x 92 x 204 h
Potenza max 2,3 kW/Max power 2,3 kW

La sauna è realizzata interamente in abete di risonanza. L'illuminazione interna crea un particolare effetto raggiato grazie alla azione della luce diffusa da una lampada sulle doghe del rivestimento. L'arredo è completato da una panca in abete. La maniglia sempre in legno è integrata in tutto il lato lungo della porta per una presa sicura ed una naturale presenza decorativa.

Sauna is made entirely by fir resonance. The inner lighting creates a unique effect, thanks to a lamp placed on the wall. A fir bench completes the arrangement. The wood handle is built in the entire length of the door providing easy grip and a natural touch





x 2/3

Talia 160 x 127 x 204 h
Potenza max3 kW/Max power 3 kW

Misure disponibili / Available sizes



120 x 92 x 204 h
Potenza max 2,3 kW



200 x 192 x 204 h
Potenza max 6 kW



120 x 127 x 204 h
Potenza max 2,3 kW
dx-sx



250 x 192 x 204 h
Potenza max 9 kW



160 x 127 x 204 h
Potenza max 3 kW



300 x 192 x 204 h
Potenza max 9 kW



200 x 142 x 204 h
Potenza max 4,5 kW

ALLESTIMENTI TALIA

Talia equipment

Finiture

- Esterno: Abete rosso
- Interno: Abete rosso
- Arredamenti: Abete rosso

Allestimento

- Mestolo in legno
- Mastellino in legno
- Mensole
- Porta salviette
- Porta accappatoi
- Lampada interna 220w
- Basamento con piedini regolabili
- Porta vetro temperato, spessore 6 mm
- Cerniere regolabili su tre dimensioni
- Stufa con pietre
- Pannello di controllo:
 pannello digitale dotato di display grafico lcd blu retroilluminato a led bianchi; orologio con datario, controllo e gestione tempo e temperatura, preimpostazione di accensione e clessidra elettronica

Optional

Sauna

- Poggiaschiena double-face
- Poggiatesta
- Vetro Stopsol
- Sistema audio:
 predisposizione radio FM con 8 stazioni memorizzabili; ingresso ausiliario via jack stereo per iPod®/iPad®; 2 casse stereo ausiliarie
- Cromoterapia diffusa a led rgb con 3 cicli, cambio colore automatici e funzione iride da 42 colori (sostituisce la lampada interna di serie)
- Fungo di emergenza
- Protezione in Laminam®

Finishing

- External: Fir
- Inside: Fir
- Furnishing: Fir

Setting

- Ladle in wood
- Bucket in wood
- Shelf for essences / glasses
- Towels holder
- Head rest (included in some models)
- Bathrobe hook
- Inside lamp 220w
- Base with adjustable feet
- 6 mm tempered glass enclosure
- Stove with stones
- Control panel:
 Digital panel endowed with graphic lcd blue display backlit with white leds.
- Clock with date, control and management time and temperature, switch on pre-setting and electronic hourglass

Optional

- Double-face back rest
- Additional head rest
- Stopsol glass
- Audio system:
 Predisposition for FM radio with 8 storable channels
 Auxiliary entry by stereo jack for iPod® connection
 2 additional stereo speakers
- Chrome-therapy spread by RGB leds with 3 cycles, automatic color change and 42 colors iris function (it replaces inside lamp)
- Emergency push-button
- Flat protection plate in LAMINAM®



Realizzazioni anche su misura
 Can be custom-made.



KYRA

L'alto valore e la straordinaria tradizione della sauna in abete
di risonanza disegnata con uno stile contemporaneo
e minimalista dalla forma pura.

The superior value and the extraordinary tradition of a Norway spruce sauna
designed with a contemporary and minimalist style
and a pure elegant shape.

Kyra

Sauna
192 x 192 x 204 h

Oltre la raffinata parete in vetro stop sol con porta battente e cerniere eleganti, si apre uno spazio dal comfort naturale. Le funzioni della sauna sono controllate da un touch screen perfettamente integrato nella forma e nello stile di Kyra, con tasti che s'illuminano appena sfiorati.

Beyond the sophisticated stop sol glass wall with a hinged door on elegant hinges lies a space oozing natural comfort. The sauna functions are controlled on a touch screen which blends in seamlessly with the structure and style of Kyra, with keys that light up as soon as you touch them.









Kyra

Sauna
246 x 192 x 204 h



ALLESTIMENTI KYRA

Talia equipment

Finiture

- Esterno: Abete
- Interno: Abete
- Arredamenti: Abete

Allestimento

- Mestolo in legno
- Mastellino in legno
- Lampada interna 220w
- Basamento con piedini regolabili
- Porta vetro temperato, spessore 6 mm
- Cerniere regolabili su tre dimensioni
- Stufa con pietre
- Pannello di controllo:
- Pannello digitale retroilluminato a Led (funzione On/Off - Luce - Impostazione Temperatura)

Optional

Sauna

- Poggiaschiene double-face
- Poggiatesta

Possibilità di esecuzione su Misura.

Finishing

- Exterior: Fir
- Interior: Fir
- Furnishings: Fir

Setting

- Wooden ladle
- Wooden pail
- 220W internal lamp
- Base with adjustable feet
- 6 mm-thick tempered glass door
- Three-way adjustable hinges
- Stove with stones
- Control panel:
- Digital LED-backlit panel (On/Off function - Light - Temperature Setting)

Optional

Sauna

- Double-sided backrest
- Headrest

Can be custom-made.



Realizzazioni anche su misura

Can be custom-made.



x 1

120 x 102 x 204 h
Potenza max 2,3 kW



x 3/4

192 x 120 x 204 h
Potenza max 3,6 kW



x 5

246 x 156 x 204 h
Potenza max 6 kW



x 2

156 x 102 x 204 h
Potenza max 3 kW



x 4

192 x 156 x 204 h
Potenza max 4,5 kW



x 5/6

246 x 192 x 204 h
Potenza max 9 kW



x 2/3

156 x 120 x 204 h
Potenza max 3 kW



x 4/5

192 x 192 x 204 h
Potenza max 6 kW



x 6

246 x 246 x 204 h
Potenza max 9 kW

GLI ACCESSORI SAUNA VITA®

Sauna Vita® accessories

Elementi coordinati per rendere ancora più personale il tuo spazio Sauna Vita, accessori per arredare e dare più funzionalità alla sauna. Dall'esclusiva chaise longue alla panca e al tavolino in legno e fuselli in acciaio con struttura in acciaio inox, dai comodi poggia schiena e poggia testa agli oggetti per la gestione della sauna, la collezione degli accessori è studiata per darti il massimo del comfort.

Coordinated elements to make your Sauna Vita space even more personal, accessories to furnish your sauna and make it more practical. From the exclusive chaise longue to the bench and table made of wood and beech spindles with a stainless steel structure, from comfortable backrests and headrests to objects to manage your sauna, the collection of accessories is designed to give you maximum comfort.

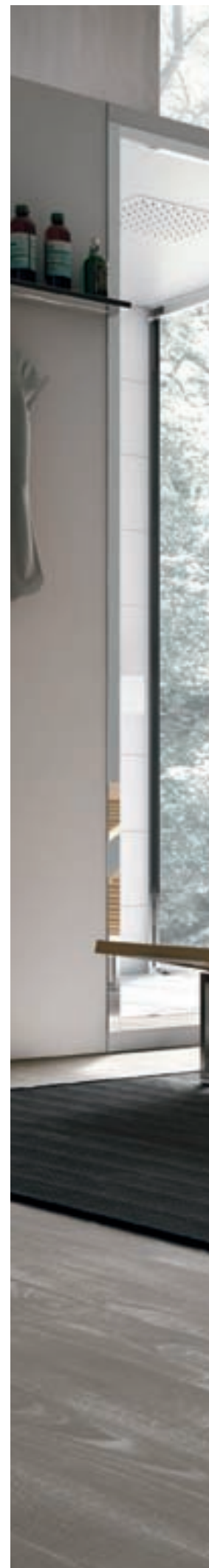
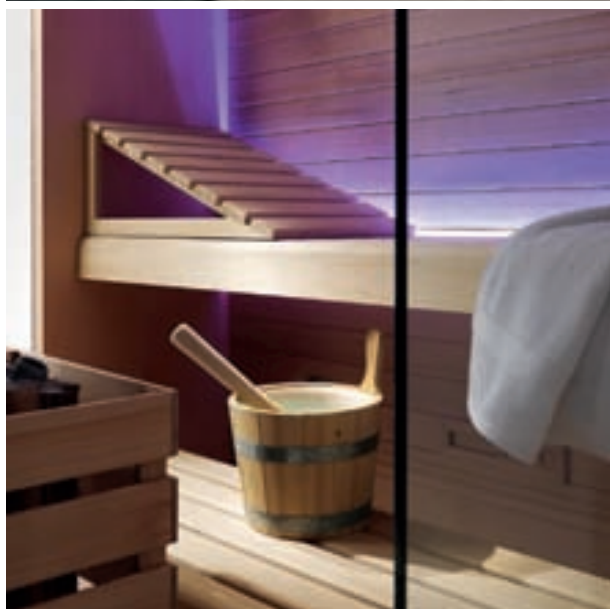





SAUNAVITA®
calore naturale

HAFRO
acqua, per piacere

**BAGNO TURCO
PROFESSIONAL**

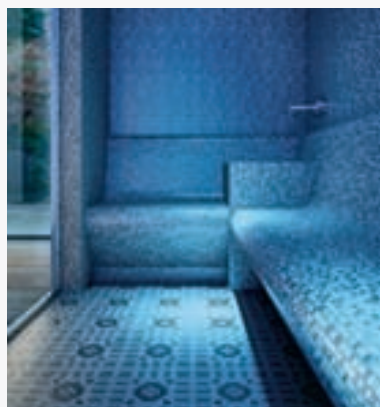

SV Steam
page 106

**BAGNO TURCO
RESIDENZIALE**



Programma Rigenera
page 140

Chiusura Gemini
page 162

BAGNO TURCO PROFESSIONAL

STEAM BATH PROFESSIONAL

Hamam, nella lingua originale, è una particolare situazione ambientale ottenuta mediante la combinazione di umidità e calore. L'umidità relativa dell'80% e la temperatura di 40 gradi creano una nube di vapore acqueo che provoca una intensa sudorazione. La temperatura meno elevata, rispetto alla sauna, ne contiene peraltro la quantità, ma i tempi di permanenza più lunghi favoriscono una maggior perdita di liquidi, beneficiando il sistema respiratorio, favorendo la purificazione della pelle e la riduzione dello stress. Benefici che risultano amplificati dall'abbinamento con successiva doccia fredda.

Hamam, in the original language, is a particular environment situation obtained through the combination of damp and heat. The 80% relative damp and the temperature of 40 degrees create a cloud of aqueous steam that causes an intense perspiration. The least elevated temperature, in comparison to the sauna, restrain the quantity of it, but the longer times of permanence favours a greater loss of liquids, benefiting the respiratory system favouring the purification of the skin and the reduction the stressing. These benefits result amplified by the combination with following cold shower.

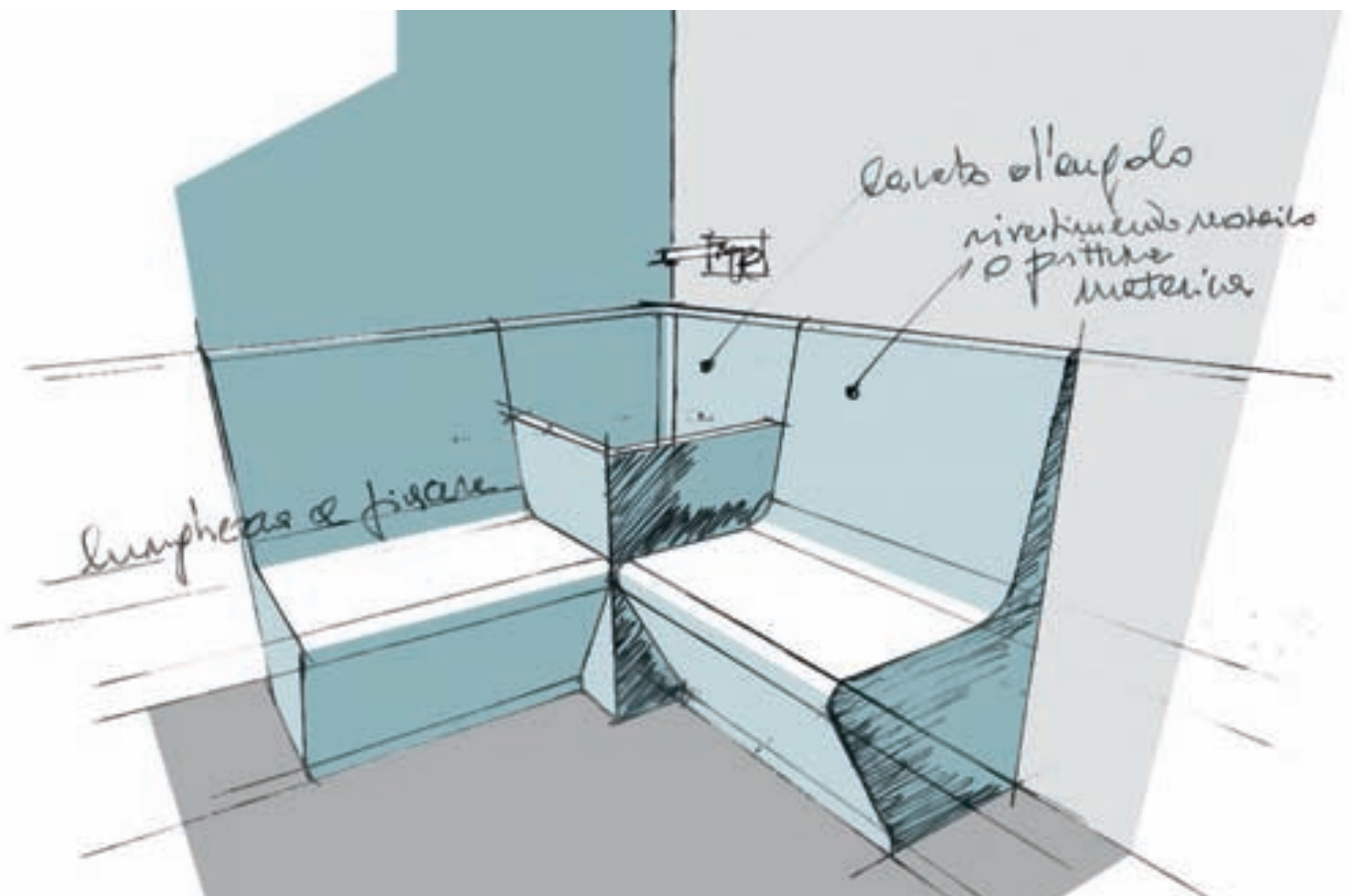



**ARCHI
TETTURE
PER VIVERE
L'ESPERIENZA
STRAORDINARIA
DEL VAPORE**

Architecture for living the extraordinary experience of steam

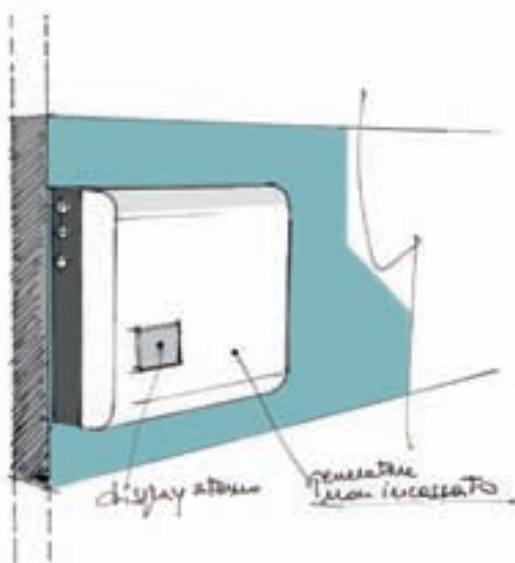



Stanza 250 x 150 con generatore SV Steam semi-incasso
250 x 150 with semi-encased mounting steam generator



AMBIENTI SU MISURA

Made-to-measure spaces

Due soluzioni hammam per la casa e le Spa, con una diversa localizzazione del generatore di vapore: da incassare o posizionare in vani tecnici dedicati. Tecnologia avanzata per una nuova modalità di allestimento.

Two different hammam proposals, both for residential and Spa, with two different positions of the steam generator: encased into the wall or installed externally in a technical space. Advanced technology to create a new way of setting up.







Generatore di vapore esterno **SV Steam** (6 - 7.5 - 9 - 12 kW) e **SV Steam mini** (3 - 4 - 5 kW), per installazione a semi-incasso o a parete in vani tecnici adibiti, display integrato o remoto LCD per la gestione delle funzioni bagno turco, cromoterapia, sistema audio e bluetooth.

SV Steam generator for external installation (6 - 7.5 - 9 - 12 kW) and **small SV Steam** (3 - 4 - 5 kW), built in wall installation or external installation in technical spaces. Integrated or remote LCD display to control every function. Turkish bath, colour therapy, hi fi system and Bluetooth.

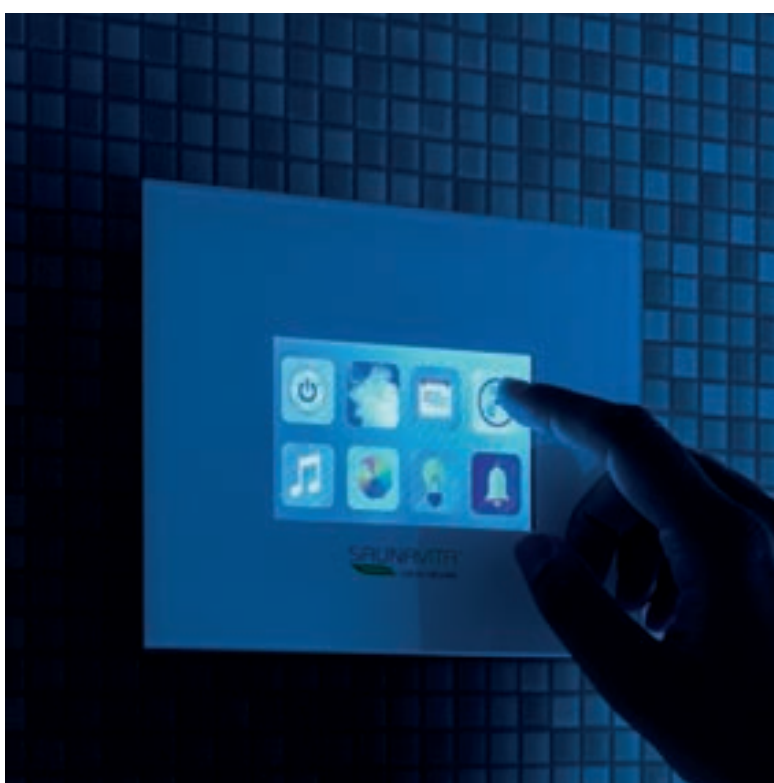

Display Lcd per il controllo di tutte le funzioni.

Keyboard
Lcd display keyboard to manage every function.

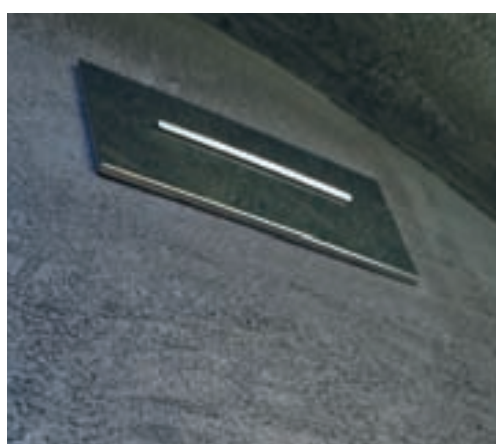

Luce e cromoterapia
Light and colour therapy

La terapia dei colori per una raffinata pratica di benessere.

Colour therapy to give refined well being.

Sistema audio
Hi fi sound system

Sistema audio dotato di casse per la diffusione del suono e uscita USB per la connessione dei dispositivi audio.

Hi - fi sound system with speakers to fill the room with sound. USB output to connect audio devices.





Stanza 200 x 200 con generatore SV Steam mini esterno
200 x 200 with External version mounting small steam generator



Steam Mini è la soluzione con una potenza ideale per gli ambienti contenuti che vanno dai 3,5 ai 4,5 metri cubi. Grazie al suo design moderno, può essere installato sulla parete oppure alloggiato comodamente in un vano tecnico per lasciare l'estetica assolutamente pulita.

Steam Mini is a solution with an ideal power rating for confined spaces ranging between 3.5 and 4.5 cubic metres. Thanks to its modern design, it can be installed on the wall or housed conveniently in a technical compartment, affording perfectly clean-cut styling.



ELEMENTI BAGNO TURCO PROFESSIONAL

TURKISH BATH PROFESSIONAL

IL VERO BAGNO DI VAPORE PENSATO PER LA CASA

The true steam bath designed for the home

Con Hafro, ogni casa può dotarsi di un bagno di vapore di qualità professionale. Dallo studio approfondito della funzionalità architettonica e dell'evoluzione tecnologica, sono nati due sistemi che permettono di rispondere ad ogni esigenza: l'ambiente Gemini e l'allestimento SV Steam. L'obiettivo è adattarsi perfettamente alla stanza prescelta curando ogni dettaglio, sapendo che la qualità dei materiali e l'eleganza delle forme sono elementi irrinunciabili. Bellezza e benessere vanno sempre insieme.

With Hafro, every house can have a professional quality steam bath. From in-depth study of architectural functionality and technological evolution, two systems have been born that can meet every need: the Gemini environment and the SV Steam equipment. The aim is for it to integrate perfectly with the room selected, taking care of every detail, knowing that the quality of the materials and elegance of the shapes are fundamental elements. Beauty and wellness always go together.



Kit coibentazione
Insulation kit

Porta con fisso
Door + fixed element

Generatore di vapore
External steam
generator



SV steam

GENERATORE INSTALLAZIONE ESTERNO

External steam generator



SV STEAM MINI

Esterno / External version
L 58 - H 31,5 - P 13 cm

Potenza assorbita / Power
3 - 4 - 5 kW

SV STEAM

Esterno / External version
L 52 - H 44 - P 18 cm

Potenza assorbita / Power
6 - 7,5 - 9 - 12 kW

USB



Uscita USB per connettere i propri dispositivi.

USB
USB port to connect your devices.

TASTIERA



Display lcd per il controllo di tutte le funzioni.

Keyboard
Lcd display keyboard to manage every function.



AMBIENTE



Sv Steam è in grado di soddisfare ambienti fino a 14-15 m³

Ambience
Steam generator suitable for ambience up to 14-15 mc.

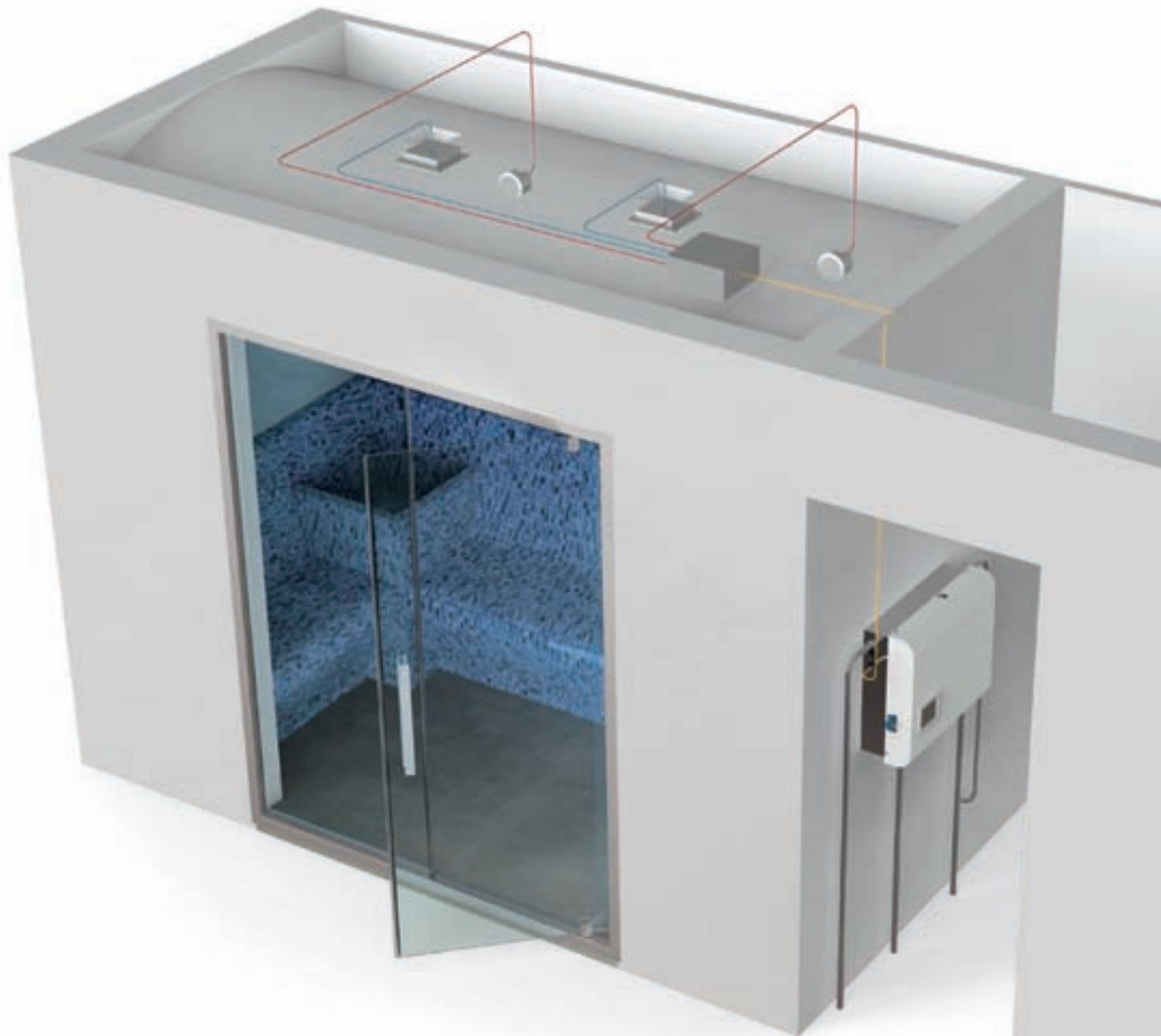

L'installazione a parete (vano tecnico), è l'ideale per l'utilizzo professionale.
La gestione delle funzioni può essere controllata direttamente,
con display a bordo del generatore di vapore, o in modalità remota tramite display lcd.

Wall installation (technical compartment) is ideal for the professional use.
Selection of functions can be managed directly through a LCD integrated display,
or managed remotely.

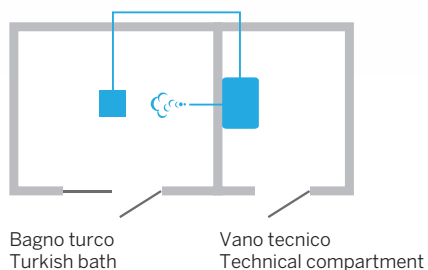

SV steam

GENERATORE INSTALLAZIONE SEMI-INCASSO

Semi-encased mounting steam generator

SV STEAM

Semi-incasso / Semi-encased mounting

L 52 - H 44 - P 9 cm

Potenza assorbita / Power

6 - 7,5 - 9 - 12 kW



USB



Uscita USB per connettere i propri dispositivi.

USB

USB port to connect your devices.

TASTIERA



Display lcd per il controllo di tutte le funzioni.

Keyboard

Lcd display keyboard to manage every function.



AMBIENTE



Sv Steam è in grado di soddisfare ambienti fino a 14-15 m³

Ambience

Steam generator suitable for ambience up to 14-15 mc.



Il generatore a semi-incasso diventa elemento d'arredo, elegante e lineare.
 Il display lcd, posto all'interno dell' hammam, permette il controllo di tutte le funzioni.
 Ideale per l'utilizzo domestico.

Semi-encased steam generator becomes a design element, elegant and with clean style.
 Lcd display enables to manage every function from the inside of the hammam.

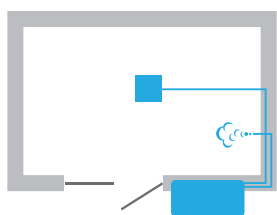

Bagno turco
 Turkish bath

LA COIBENTAZIONE: PIÙ RESA, MENO CONSUMI

The insulation: greater performance, lower consumption

Coibentare le pareti ed il soffitto del vano assicura una resa migliore ed un minor consumo di energia, evitando dispersione di calore. Saunavita comprende un kit di pannelli completamente isolanti da 60 x 125 cm, spessi 3 cm, rivestiti in malta cementizia. Il rivestimento di finitura, mosaico o piastrelle, e le eventuali opere in muratura o cartongesso richieste, rientrano nell'ambito della personalizzazione dell'ambiente.

Insulating the walls and the ceiling of the room ensures greater output and lower energy consumption, by avoiding heat dispersal. Saunavita includes a kit of 60 x 125 cm, 3cm thick panels, which insulate completely and are covered in cement mortar. Their finishings, in mosaic or tiles, and any brickwork or plasterboarding can be freely personalised by the client.

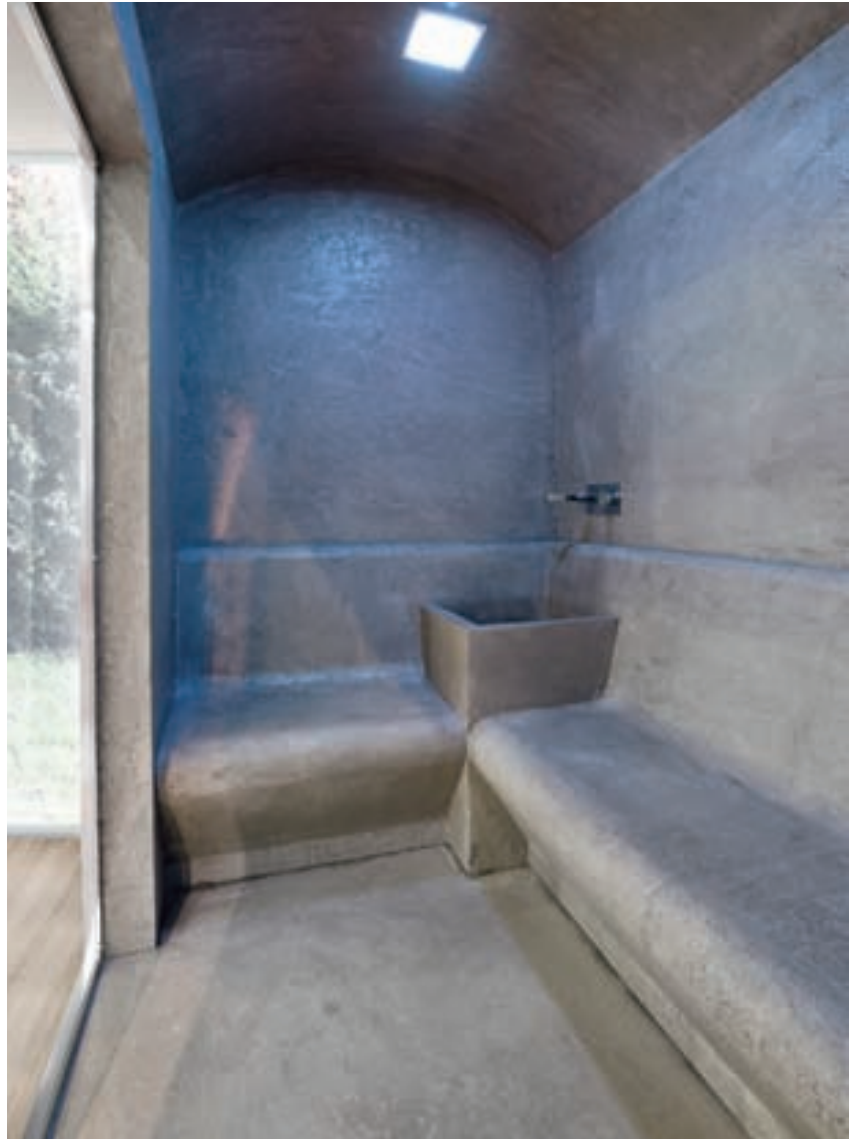

Kit coibentazione / Insulation kit



Pannelli isolanti da 60 x 125 cm
Insulating panels 60 x 125 cms

Finitura per ricoprire: mosaico o piastrelle
Finish to cover: mosaic or tiles

ESEMPIO DI STRUTTURE

Framework

Lo spazio richiesto
 Sv Steam è in grado di soddisfare
 ambienti fino a 14-15 m³

Space needing
 Steam generator suitable for
 ambience up to 14-15 mc.



SOFFITTO

Ceiling

Il soffitto a cupola o spiovente anti gocciolamento A dome or steep drip-proof ceiling

Evita l'effetto pioggia quando il vapore si condensa.
Se la scelta ricade sul soffitto spiovente la pendenza deve essere almeno del 15%.

These two shapes avoid the rain effect when steam condenses. In the case of the steep roof, the pitch should be at least 15%.



Volta a botte
Barrel vaulted ceiling



Soffitto inclinato
Sloping ceiling



Volta a crociera
Cross vault ceiling

SEDUTE

Seat

Sedute a muro rivestibili (su misura) On wall coverable seat (custom made size)

Seduta lineare
con schienale
Linear seat with
backrest



Seduta lineare
senza schienale
Linear seat
without backrest



Seduta ad angolo
con schienale
Corner installation
seat with backrest



Seduta ad angolo
senza schienale
Corner installation seat
without backrest

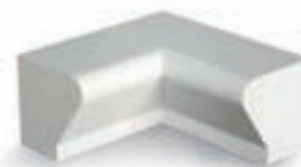

Seduta curva con
schienale
Curved seat with
backrest



Seduta curva senza
schienale
Curved seat without
backrest



ANGOLO LAVABO Sink





PORTE E VETRATE

Doors and windows

Porte ed elementi fissi in cristallo Doors and crystal glass fixed elements

Componenti fondamentali per garantire il corretto funzionamento del bagno di vapore. Le porte e gli elementi fissi, entrambi in cristallo temperato da 6 mm, sono espressamente creati per assolvere alla funzione di tenuta del vapore ed evitare l'entrata di aria fredda.

Fundamental components to preserve the proper function of the Turkish bath. Doors and fixed elements, both in crystal glass 6 mm thick, are specially designed to perform steam keeping and avoid fresh air incoming.

Porta
Door



Porta con fisso
Door + fixed element



Elemento fisso
Fixed element



ACCESSORI

Basin

Touch screen LCD display
per il comando remoto
delle funzioni.

Touch screen LCD display
to manage every function.



Versione con tastiera completa
di LDC display e docetta

Version with full keyboard
LDC display and handshower



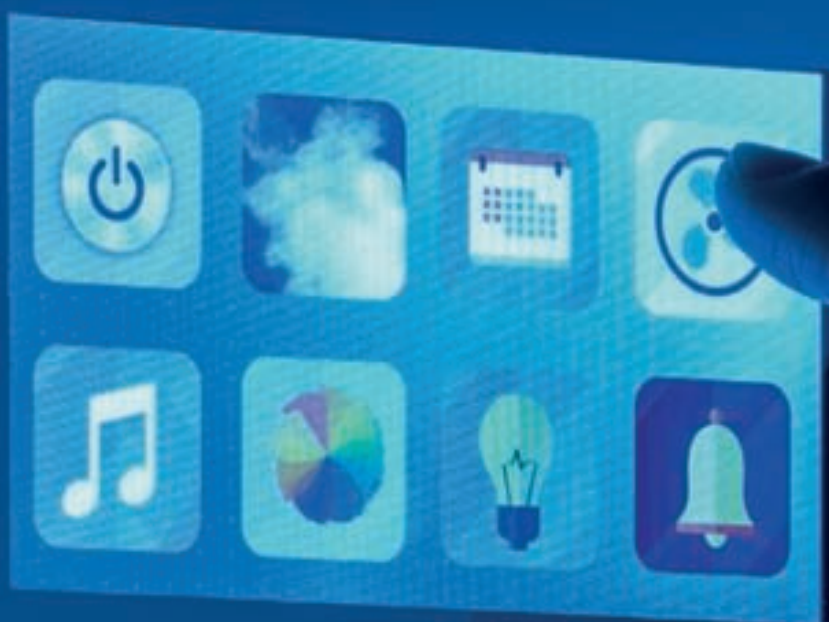

SAUNAVITA[®]
calore naturale

ACCESSORI

Basin

Luce e cromoterapia Colour therapy and light

Una doccia di luce colorata. Questa è la magnifica sensazione della cromoterapia, una raffinata pratica di benessere. I faretto inseriti nell'ambiente bagno turco irradiano la luce alla giusta frequenza per ottenere dai colori gli effetti migliori.

A shower of coloured light. This is the extraordinary sensation of colour therapy, a refined well being experience. The spotlights irradiate light at the right frequency to obtain the best effect from the colours.

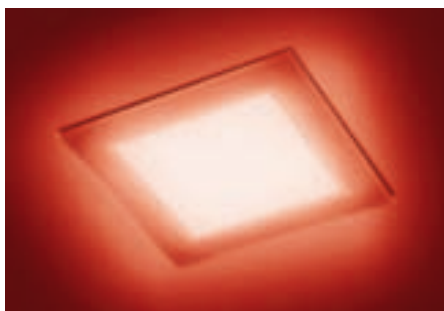

Audio

Sistema audio dotato di casse per la diffusione del suono e uscita USB per la connessione dei dispositivi audio.

Hi - fi sound system with speakers to fill the room with sound. USB output to connect audio devices.





BAGNO TURCO RESIDENZIALE

TURKISH BATH

Con Hafro, ogni casa può dotarsi di un Hammam. La pratica salutare del bagno di vapore non è più esclusiva dei sistemi professionali o di ambienti speciali, ma grazie alla conoscenza dei materiali e allo sviluppo di nuove tecniche progettuali può essere portata con pieno successo e soddisfazione nel bagno di casa.

Il bagno turco è una pratica molto utile ed efficace per gestire naturalmente lo stress della vita contemporanea e per questo Hafro lo ha immaginato facilmente inseribile in ogni casa. Un obiettivo che ha dato vita a sistemi innovativi per incontrare tutte le esigenze e darti nuove meravigliose possibilità di benessere.

With Hafro, every home can have its own steam bath. The health-giving properties of steam baths are no longer exclusively the realm of professional systems or specialist locations, but, thanks to improved knowledge of materials and the development of new design techniques, they can very successfully and satisfactorily be brought into the home bathroom. Turkish baths are a very useful and effective way of naturally managing the stresses of contemporary life and that is why Hafro decided that they could easily become part of any home. This objective gave rise to innovative systems that fulfil all your needs and give you wonderful new opportunities for wellness

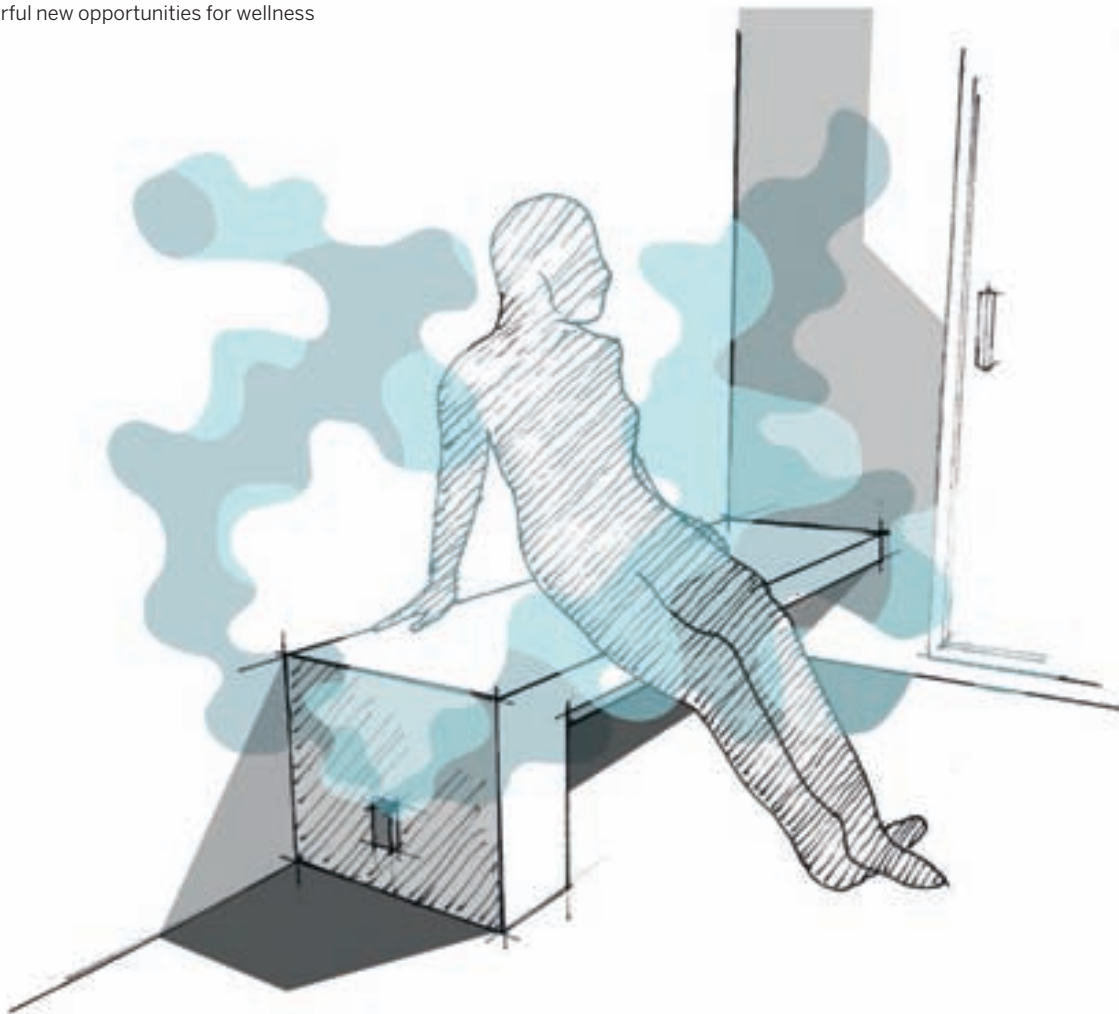



**IN OGNI
CASA
TUTTO
IL BELLO
DEL
VAPORE**

All the beauty of steam
in every home



CREA IL TUO AMBIENTE BAGNO TURCO

CREATE YOUR TURKISH BATH

La tecnica evoluta messa a punto da Hafro consente di realizzare, con grande facilità, un vero e proprio bagno turco in qualsiasi ambiente.

I benefici effetti di questa antica pratica salutare, in termini di relax psico fisico e di profonda depurazione dell'organismo, si possono pienamente ottenere senza allontanarsi dalle mura domestiche. Hafro fornisce tutto il necessario.

Un ambiente dotato di una normale presa di corrente, un punto di erogazione d'acqua e la meravigliosa avventura del bagno turco può cominciare.

The evolved technology advanced by Hafro allows to create easily a real Turkish bath in every single house. All benefits of this ancient practice, in terms of psycho/physical relax and deep purification of the organism, is now available with a simple installation. All they need is a standard power outlet and cold water connection and the extraordinary adventure of the Turkish bath can start.

Requisiti dell'ambiente:

- Altezza massima di 220 cm;
- Soffitto a volta oppure spiovente;
- Pareti coibentate;
- Porte e vetrate a tenuta stagna;
- Pavimento impermeabilizzato con piletta di scarico;
- Pareti e soffitto rivestiti interamente con materiale impermeabile

Environmental requirements:

- Maximum height of the environment 220 cm
- Closed sloping ceiling (sloping at least 15%) or to dome
- Insulated walls
- Impermeable floor with drain
- Door
- Walls and ceiling have to be covered by ceramic or similar material







GENERATORI DI VAPORE

RIGENERA 200 incasso max 7 m

Colonna con generatore di vapore per bagno turco

Shower column and steam generator

RIGENERA 200 max 3,5 m³

Colonna doccia multifunzione con generatore di vapore per bagno turco

Shower column with steam generator

RIGENERA 100 max 3,5 m³

Generatore di vapore per bagno turco

Steam generator

RIGENERA 70 max 6,5 m³

Mobile con top in Corian® con generatore di vapore

Piece of furniture with Corian® top and steam generator

Rigenera 200

incasso

Rigenera permette anche soluzioni come questa, dove la finitura interna può essere rifinita con qualsiasi materiale, purchè impermeabile al vapore, come piastrelle o pietra. Questo ambiente di 3,5 metri cubi utilizza un generatore di vapore Rigenera 200 incasso .

Being able to customize the Rigenera setting means that solutions such as this one below are also possible, can be finished with any steam-proof material, such as tiles or stone. This 3.5 m3 setting was made using a Rigenera 200 built in with steam generator.

Rigenera 200 + Sedile aggiuntivo/Additional seat



Rigenera 200 incasso in cristallo

colonna doccia multifunzione / generatore di vapore
crystal glass rigenera 200 built in - multifunction shower column / steam generator
198 x 38

Design raffinato, rivestimento in cristallo ed installazione a filo parete.
Refined design, crystal glass coating and flush with the built in installation.

Colonna con generatore di vapore Shower column with steam generator



Cromoterapia
Colour Therapy

Rubinetteria con
doccetta integrata
Faucet with integrated
hand shower

Potenza generatore di
vapore: 3-4-5-6 kW,
consente di allestire
Hammam fino a 7 mc

Steam generator power:
3-4-5-6 kW, means
Hammam till 7 mc

Sistema audio con
Bluetooth

Bluetooth Sound
System

Erogatore di vapore
Steam dispenser



La tastiera, integrata nel
cristallo, gestisce tutte
le funzioni: bagno turco,
cromoterapia e sistema audio
con bluetooth.

Thanks to built in crystal glass
keyboard it's possible to control
every function: steam generator,
colour therapy and bluetooth
sound- system.



Rigenera 200 incasso in solid surface

Rigenera 200 incasso con bagno turco max 4,5 m³

Rigenera 200 built-in wall with steam generator - max 4,5 m³

Colonna con generatore di vapore per bagno turco
Materiale di costruzione: acciaio satinato e Corian®

Shower column with steam generator
Made up by Corian® and stainless steel

Colonna con generatore di vapore

Shower column with steam generator

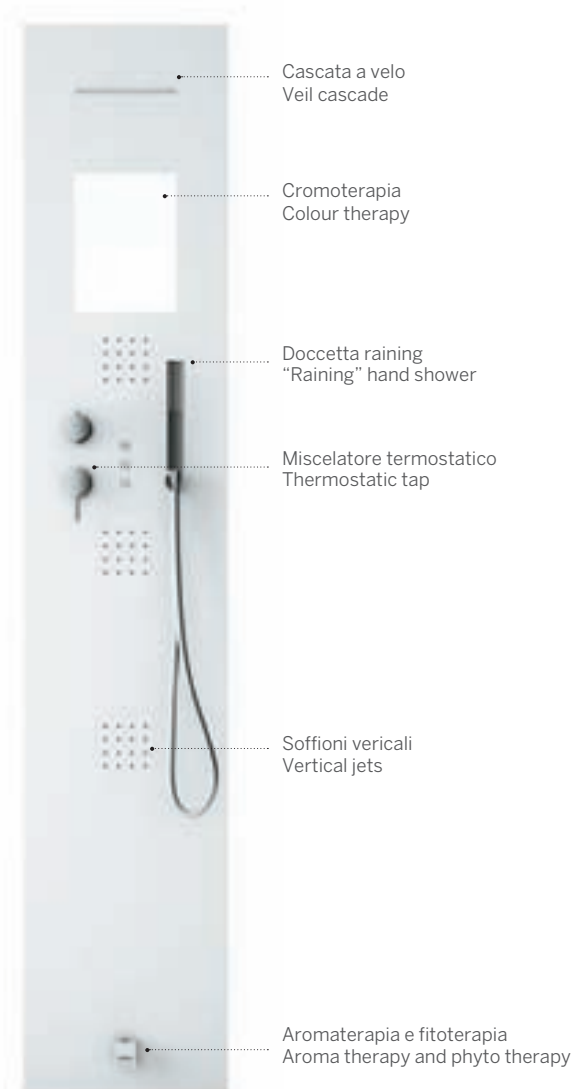



Rigenera 200

L'ambiente può essere personalizzato con qualsiasi materiale di finitura: piastrelle, mosaico od altro tipo di rivestimento, per esprimere al massimo il proprio stile di vita.

Un ambiente di 7 metri cubi, allestito con due generatori di vapore, Rigenera 100 e Rigenera 200, quest'ultima completa di doccia multifunzione. A fine giornata o dopo lo sport, lo spazio Rigenera è l'ambiente ideale per recuperare la forma psico fisica: doccia, bagno turco, idromassaggio, aromaterapia, fitoterapia.

The can be ambience customized with any finishing materials: tiles, mosaics and all types of brickwork, to best express your lifestyle. A room 7 mq wide, fitted with two steam generators: Rigenera 100 e 200. 200 version is equipped with shower.

At the end of the day, Rigenera is the ideal place for regaining your psychophysical wellbeing with its shower, Turkish bath and wellness program in a fabulous and aesthetically perfect solution.

160x90 - Rigenera 200 + Rigenera 100





Rigenera 200

I generatori di vapore, capaci di creare un temperatura di 40° con un'umidità dell'80%, sono incorporati in due diverse tipologie di colonna, entrambe dotate di sedile richiudibile e display elettronico. Il modello 200 è allestito con 6 jets idromassaggio, soffione doccia, doccetta e rubinetteria.

Steam generator, can create a temperature of 40° with 80% humidity and is incorporated into two different types of columns, both equipped with folding seats and electronic display. The 200 version equipped with 6 hydromassage jets, headshower, a small shower, taps, and fittings.



Finiture / Finishing



Corian® Bianco
White

Rigenera 100

È molto facile trovare il posto giusto per un ambiente Rigenera. Qui si è optato per un volume di 3,5 mc, con generatore di vapore inserito nella colonna Rigenera 100. Nonostante le dimensioni contenute, la qualità delle prestazioni è sempre assicurata.

It's very easy to find the right place for a Rigenera ambiente. In the following image, it has been decided to use a 3.5 mc volume with the Rigenera 100 column steam generator. Despite the limited space, performance quality is always the highest.

110x100 - Rigenera 100





Rigenera 100

Il modello Rigenera 100 è solo generatore di vapore arricchito da un dispositivo integrato per l'aromaterapia e la fitoterapia, il display elettronico e un comodo sedile richiudibile.

The Rigenera 100 model is the only steam generator enhanced with an integrated device for aromatherapy and phytotherapy, an electronic display and a comfortable fold-up seat.



Finiture / Finishing

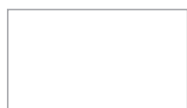

Corian® Bianco
White



Rigenera 70

Un unico mobiletto unisce fonte d'acqua, il generatore di vapore, la luce ed il dispenser aromi.
Misure disponibili: 40 x 25 h 73 cm

A single piece of furniture connects water source, steam generator, light and aroma therapy.
Available sizes: 40 x 25 h 73 cm



Il telecomando controlla le tutte le funzioni, compresa la frequenza e il volume della radio.

Remote controls all functions, including the frequency and volume of the radio.

Aromaterapia e fitoterapia
Aroma therapy and phyto therapy

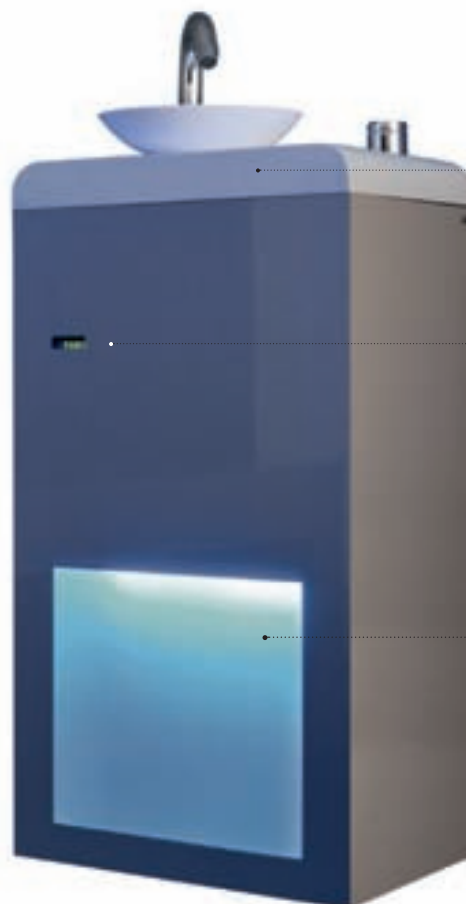

Una fonte con mini lavabo in Corian

A source with Corian sink.

Display elettronico
Electronic Display

Cromoterapia
Colour therapy

LA COIBENTAZIONE: PIÙ RESA, MENO CONSUMI

The insulation: greater performance, lower consumption

Coibentare le pareti ed il soffitto del vano assicura una resa migliore ed un minor consumo di energia, evitando dispersione di calore.

Hafro comprende un kit di pannelli completamente isolanti da 60 x 125 cm, spessi 3 cm, rivestiti in malta cementizia. Il rivestimento di finitura, mosaico o piastrelle, e le eventuali opere in muratura o cartongesso richieste, rientrano nell'ambito della personalizzazione dell'ambiente.

Insulating the walls and the ceiling of the room ensures greater output and lower energy consumption, by avoiding heat dispersal.

Hafro includes a kit of 60 x 125 cm, 3cm thick panels, which insulate completely and are covered in cement mortar. Their finishings, in mosaic or tiles, and any brickwork or plasterboarding can be freely personalised by the client.



Kit coibentazione / Insulation kit



Pannelli isolanti da 60 x 125 cm
Insulating panels 60 x 125 cms

Finitura per ricoprire: mosaico o piastrelle
Finish to cover: mosaic or tiles

SOFFITTO

Ceiling

Il soffitto a cupola o spiovente anti gocciolamento A dome or steep drip-proof ceiling

Evita l'effetto pioggia quando il vapore si condensa.
Se la scelta ricade sul soffitto spiovente la pendenza deve essere almeno del 15%.
L'altezza ottimale di 220 cm, permette di concentrare l'azione del vapore sul corpo,
evitando sprechi di energia conseguenti alla tendenza a salire dell'aria calda.

These two shapes avoid the rain effect when steam condenses. In the case of the steep roof, the pitch should be at least 15%.
220 cm: the optimum height. This height would enable the steam action to be concentrated on the body, avoiding energy wastage due.

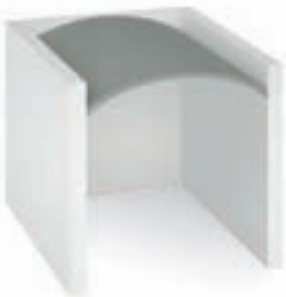

Volta a botte
Barrel vaulted ceiling



Soffitto inclinato
Sloping ceiling



Volta a crociera
Cross vault ceiling

LO SPAZIO RICHIESTO

Space needing

Lunghezza e larghezza possono variare, sapendo che un generatore di vapore a seconda della potenza può soddisfare ambienti di volume compreso tra i 3,5 mq e 7 mq.
Il flusso di vapore sarà così sempre bilanciato, con temperatura e umidità uniformi.

Lenght and width may vary, steam generator selection can satisfy space from 3,5 to 7 mq.
Steam will always be equalized, temperature and damp will always be uniform.

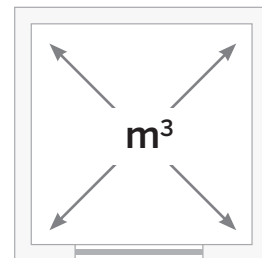

Fino a /up to 3,5 m³ = N° 1 generatore / steam (RIGENERA 200 / 100)
Fino a /up to 4,5 m³ = N° 1 generatore / steam (RIGENERA 200 incasso)
Fino a /up to 6,5 m³ = N° 1 generatore / steam (RIGENERA 70)

Fino a /up to 7/10 m³ = N° 2 generatori / steam (RIGENERA 200 / 100 / 70)



PORTE E VETRATE

Doors and windows

Sono un elemento fondamentale perché devono evitare nella maniera più assoluta l'entrata d'aria e la fuoriuscita di vapore, assicurando così un perfetto isolamento dell'ambiente. Porte e vetrate, in cristallo temperato da 6 mm, sono state realizzate espressamente per questa funzione, con un design essenziale e pulito che ne facilita l'inserimento in ogni tipo di locale.

These are fundamental element since they prevent air from getting in and steam from getting out, therefore completing the insulation of the room. 6 mm tempered glass doors and panels have been designed specifically to this purpose, with an essential and clean design, which enables them to be easily matched with all types of bathroom.

Porta singola
Single door



680 min / 720 max

Di facile e sicuro montaggio, esteticamente piacevole, con eleganti profili in acciaio, maniglia sagomata e una larghezza che può variare da 680 a 720 mm.

This is the simplest way to create a functional entrance in technical terms, which is easy and safe to assemble and is aesthetically pleasing, with elegant profiles made of stainless steel, a shaped handle and widths that can vary from 680 to 720 mm.

Lato fisso
Fixed sidewalls



680 min / 720 max

Le stesse caratteristiche fisiche e lo stesso design della porta si ritrovano nel lato fisso da aggiungere, una parete vetrata perfettamente isolante che allarga il senso dello spazio e dà all'ambiente un respiro maggiore.

The same physical characteristics and the same design as the door are to be found in the fixed sidewall, a perfectly insulating glass panel that enlarges the sense of space and gives the setting greater breathing space.

Vetrata
Glass door



0 min: 800 / 1000 / 1100 / 1200 max

1900

Nei bagni turchi di volume più grande, l'utilizzo della vetrata isolante, realizzata con gli stessi criteri tecnici ed estetici della porta, offre una variante progettuale di grande interesse, dando la possibilità di creare un bagno turco con pareti trasparenti.

In the larger-sized Turkish baths, the use of insulating glass doors made with the same technical and aesthetic criteria as the door offers a very interesting planning variant, offering the possibility of creating a Turkish bath with transparent walls.

COMPLEMENTI

Equipment and accessory

Per completare l'arredamento dell'ambiente si può installare un piccolo e grazioso lavamani in Corian, completo di miscelatore, sifone e piletta, per avere sempre a disposizione una gradevole fonte d'acqua fresca. La forma può essere semicircolare o rettangolare.

To complete the setting, a small and stylish Corian basin can be installed equipped with a mixer, siphon and plug, to get a refreshing supply of water at any time. It can be semi-circular or rectangular.



MISCELATORE

Mixer tap

Miscelatore monocomando con bocca di erogazione

Single lever mixer tap with spout



MISCELATORE A MURO

Wall-mounted mixer tap

Miscelatore monocomando a 2 vie

Two-way single lever mixer tap

Il soffione con effetto pioggia da 38x38 cm regala una doccia di splendide sensazioni.

Rain effect shower head with a 38x38 cm dimension gives a wonderful feeling.



ACCESSORI E PANCHE

Accessories and benches



Seduta a muro
ribaltabile
36 x 30 x h 8



Sgabello in
acrilico
40 x 24,5 x h 44



Sgabello in acciaio
e Corian®
38 x 27,8 x h 44



Sgabelli in Solid
Surface bianco
42 x 25 x h 44
37,5 x 25 x h 41,5



Panca
100 x 34 x h 45



Sgabello
45 x 34 x h 45



Luce e cromoterapia / Colour therapy and light

Una doccia di luce colorata. Questa è la magnifica sensazione della cromoterapia, una raffinata pratica di benessere. I faretto inseriti nell'ambiente bagno turco irradiano la luce alla giusta frequenza per ottenere dai colori gli effetti migliori.

A shower of coloured light. This is the extraordinary sensation of colour therapy, a refined well being experience. The spotlights irradiate light at the right frequency to obtain the best effect from the colours.

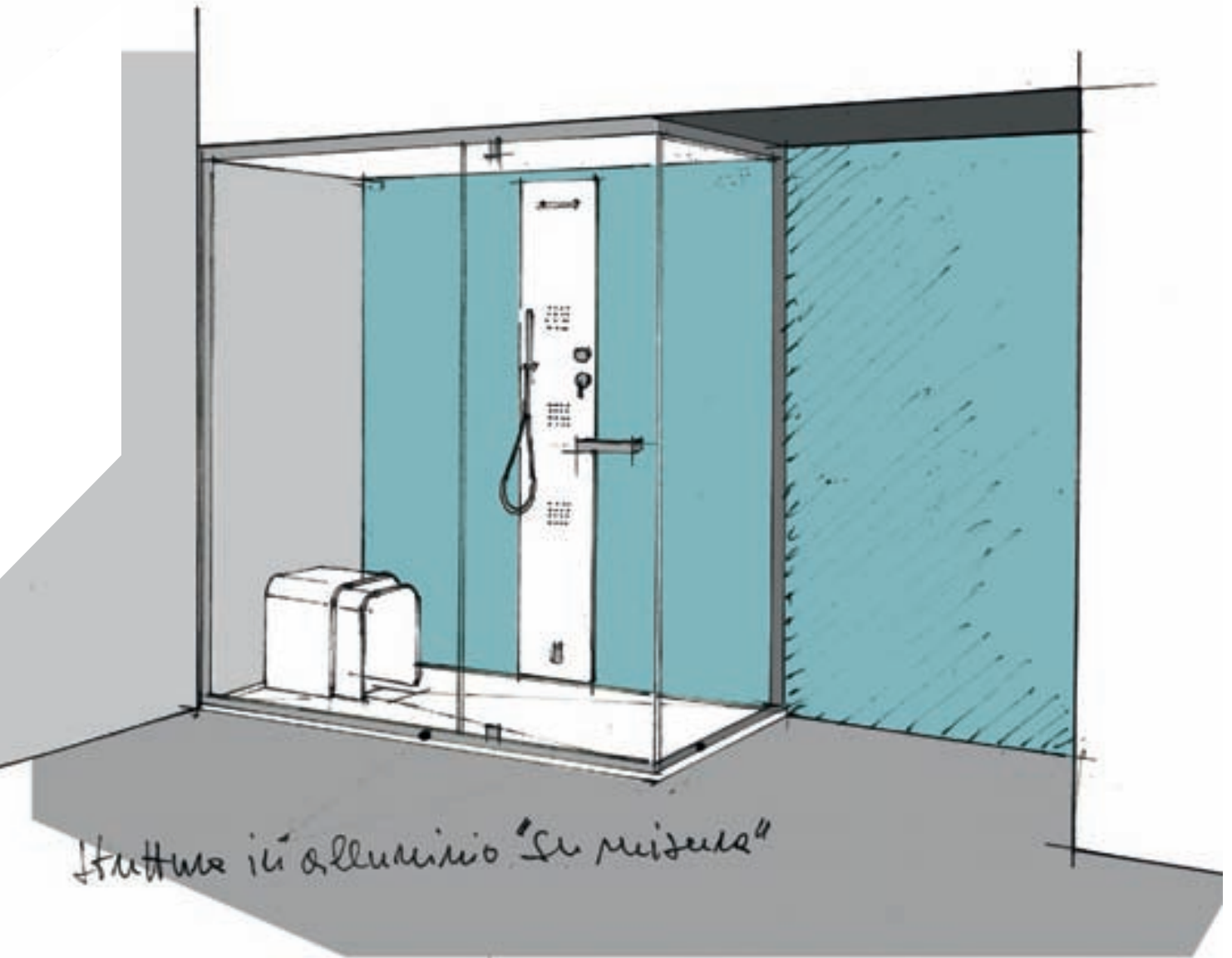

GEMINI

UN AMBIENTE GIÀ PRONTO

Gemini: a ready-made space

/ Design **Franco Bertoli**

Design, ricerca estetica e funzionale. Gemini è la risposta più semplice, veloce ed efficace al desiderio di un bagno turco che si inserisca perfettamente nel bagno di casa, da installare direttamente senza bisogno di opere particolari. Con Gemini, Hafro ti offre un progetto già pronto da adattare alle tue esigenze. Le dimensioni sono versatili, il tetto personalizzabile e le pareti eleganti e sicure. Gemini è l'esperienza e la tecnologia Hafro sintetizzate in un modello esclusivo.

Design, aesthetic and functional research. Gemini is the simplest, fastest and most effective solution to the desire for a Turkish bath that fits perfectly into your bathroom at home, to be installed directly without any need for special building work.

With Gemini, Hafro offers you a ready-made design that can be adapted to your requirements. There are versatile sizes, a personalisable roof and elegant, safe walls.

Gemini fuses Hafro experience and technology in an exclusive model.

CHIUSURA IN VETRO 8 MM GEMINI

CON TRATTAMENTO ANTICALCARE

Gemini glass catch with preventive treatment



La tua stanza Hammam già pronta

Your Hammam, already done

Grazie a Gemini è possibile progettare ambienti per il bagno turco con dimensioni fino a 190x120 cm (h. 214 cm). Pareti in cristallo temperato da 8 mm, tetto coibentato placcato in acrilico, tetto semplice o con soffione o con soffione e cromoterapia. Gemini può essere installato con tutti i piatti doccia Hafro, o direttamente sul pavimento. Con un unico prodotto potrai avere una stanza hammam di immediato utilizzo senza opere di muratura ed economicamente vantaggiosa. Gemini si combina perfettamente con qualsiasi generatore di vapore.

Thanks to Gemini it's possible to set your own hammam in your house, it could measure up to 190x120 cm. Crystal glass wall it's 8 mm thick, the roof is insulated thanks to a special equipment made by aluminium and polyurethane. Head shower is built into the roof. Gemini could be fitted on every Hafro shower tray or on the floor.





Rigenera 70 con ambiente Gemini

Rigenera 70 with gemini area



Rigenera 200 incasso con ambiente Gemini

Rigenera 200 built-in wall installation and Gemini ambience

Un progetto esclusivo: la linea Rigenera viene ampliata, inserendo una colonna da incasso con generatore di vapore. Le soluzioni sono molteplici: grazie a Gemini è possibile creare l'ambiente hammam su misura.

An exclusive project: Rigenera collection has been improve, thanks to a built in shower column, equipped with a steam generator. Solutions become several: thanks to Gemini is possible to create your own hammam room.

Rigenera 200 incasso

- colonna in solid surface
- miscelatore termostatico
- doccetta Raining
- cascata a velo
- soffioni verticali
- erogatore di vapore con aromaterapia e fitoterapia
- cromoterapia

- solid surface column
- thermostatic tap
- rain effect hadshower
- veil cascade
- vertical jets
- aromatherapy and phytotherapy
- steam generator
- colourtherapy





ALLESTIMENTI

Equipment

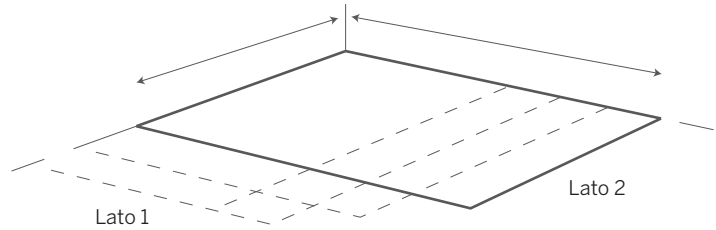

- Lato fisso
- Lato porta
- Dimensione massima: 190 x 120 cm
- H. 214 cm
- L'apertura può essere lato destro o sinistro oppure frontale

- Crystal glass panel
- Crystal glass door
- Max measurement: 190 x 120 cm
- H. 214 cm
- The entrance could be placed on the left, on the right or on the front

INSTALLAZIONE

Installation

Installazione ad angolo /
Corner installation



Apertura frontale o laterale
Front or side entrance

Installazione a parete /
Wall installation



Apertura frontale o laterale
Front or side entrance

Installazione a nicchia /
Niche installation



Apertura frontale
Front entrance

TETTO

Roof

Si può scegliere il tetto in versione semplice, oppure dotarlo di soffione anche con la cromoterapia.

It's possible to order the roof without accessories or equipped with headshower and colour therapy.

Tetto / Roof



Tetto con soffione / Built-in roof headshower



Tetto con soffione e cromoterapia / Built-in roof headshower and colour therapy



GENERATORI DI VAPORE

Steam generator

Rigenera 200 incasso con bagno turco max 4,5 m³



Colonna con generatore di vapore per bagno turco.

Shower column and steam generator.

Rigenera 70 max 6,5 m³



Mobile con top in Corian[®] con generatore di vapore.

Piece of furniture with Corian[®] top and steam generator.

Rigenera 100 max 3,5 m³



Generatore di vapore per bagno turco.

Steam generator.

Rigenera 200 max 4,5 m³



Colonna doccia multifunzione con generatore di vapore per bagno turco.

Shower column with steam generator.



**NEGLI AMBIENTI DOCCIA
O NELLE VASCHE,
L'ACQUA CON DIVERSE
INTENSITÀ ED EFFETTI
E L'ARIA CON MIRIADI
DI MICRO FLUSSI
FRIZZANTI CREANO
UN'ESPERIENZA UNICA.**

IN SHOWER AREAS AND
IN BATHTUBS, WATER AT
DIFFERENT INTENSITIES AND
WITH DIFFERENT EFFECTS,
AND AIR THROUGH A MYRIAD
OF SPARKLING MICRO
SPRAYS, CREATE A UNIQUE
EXPERIENCE.



HYDROMASSAGE

A REAL PERSONAL OASIS

MINIPISCINE

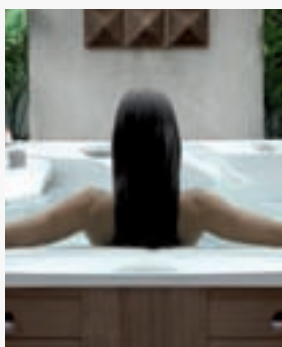

Dream
Country
Sun
Avenue

**BOX DOCCIA
MULTIFUNZIONE**



Talos Plus
Tempo curvo
Tempo
Soul
Sound
New Bi-Size

**BOX A
COMPOSIZIONE**



Time
Bristol Box

**COLONNE
DOCCIA**

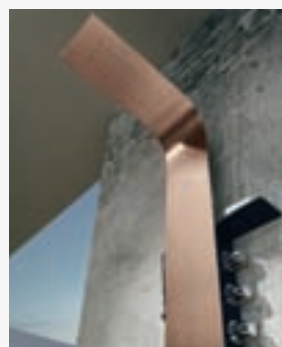

Linea Lama
Plane
Brill Plus
Light / Light Plus
Bridge Plus
Linea Etoile
Rigenera 200
Quarantacinque
Quarantacinque S



PIATTI DOCCIA

**VASCHE
IDROMASSAGGIO**

**VASCHE
COMBinate**

**VASCHE
AD INCASSO**

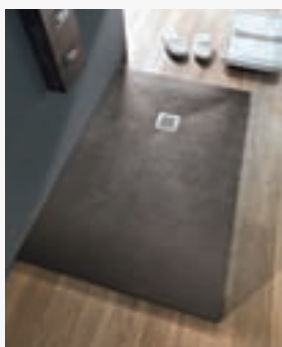

Forma
Pietrafina
Corian®
Zeroquattro

Linea Sensual
Bolla Q Sfiro 190x190
Bolla Q 160x160
Bolla Sfiro 190
Bolla 160
For All
Zaphiro
Oasy
Linea Mode
Linea Era
Eva
Duo
Ondaria
Nemesi
Gamma
Old Time
Armony Plus
Sinuhè
Igloo
Ego
Diva
Linea Nova

For All Box
Era Plus Box/Era Box
Duo Box
Linea Nova Box

Bolla Q
Bolla
Bolla R
Igloo
Sinuhè
Ego
Era
Diva
Nova
Armony Plus
Zaphiro
Oasy
Mode
Eva
Ondaria
Duo
Nemesi
Gamma
Nova

MINIPISCINE

MINIPOOL

Le minipiscine Hafro sono il luogo delle grandi emozioni. Il design unisce in forme originali ergonomia ed estetica, la conoscenza e la tecnologia dell'acqua portano il benessere ad un livello straordinario, da vivere, come un piccolo mare privato, nella piena comodità della propria casa.

Hafro spas are the place of intense emotions. The design combines ergonomics and styling in original shapes, whereby water technology and know-how take wellness to an extraordinary level, to be experienced like a small, private sea, in the comfort of your own home.

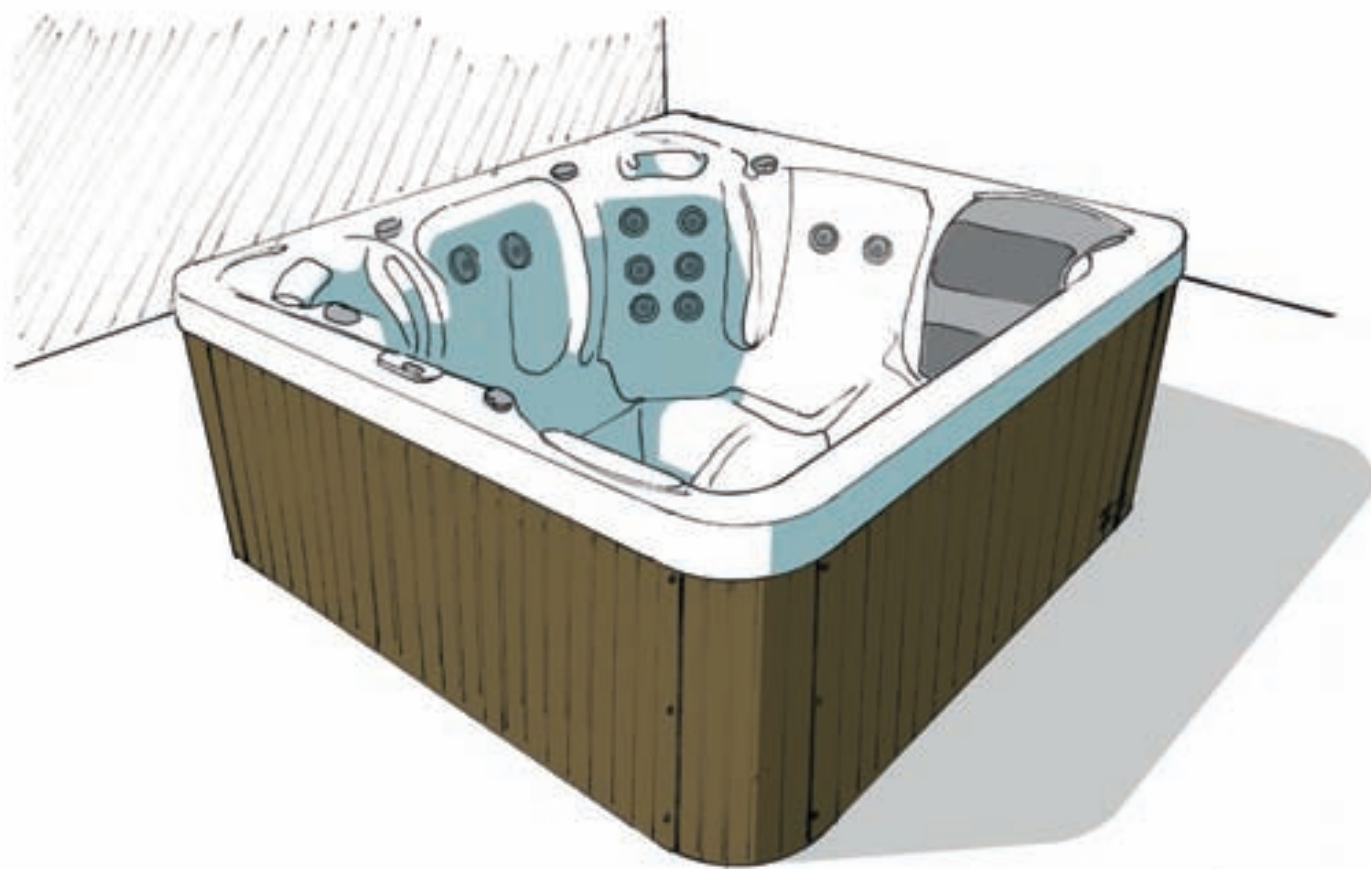



**IMMERSI
NELLA
VIVACITÀ
DELL'ACQUA
PER INDI-
MENTI
CABILI
MOMENTI
DI RELAX**

Plunged into the brilliance
of water for unforgettable
moments of relaxation

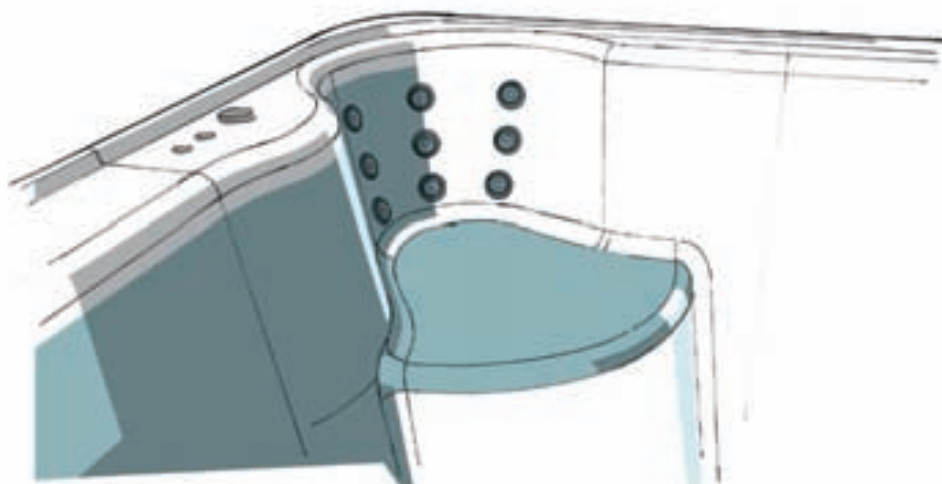

IDROMASSAGGIO E SEDUTE ERGONOMICHE

Hydro massage and ergonomic seating

Le minipiscine sono realizzate non solo per apparire belle, ma anche per superare tutte le norme di idromassaggio e l'ergonomia di alta qualità. Abbiamo impostato con attenzione le posizioni d'acqua e prestazioni per soddisfare il particolare gruppo muscolare che si vuol massaggiare. Il risultato è una gamma di stazioni di idroterapia che corrispondono a una vasta gamma di fisici, offrono un idromassaggio altamente efficace per tutte le zone e sono luoghi piacevoli e confortevoli per sedersi o sdraiarsi.

Our spas are designed, not just to look beautiful, but also to exceed all the norms for high quality hydro massage and ergonomics. We carefully set the jet positions and performance characteristics to suit the particular target muscle group. The result is a range of hydrotherapy stations that fit a wide range of physiques, provide highly effective hydromassage to all the right places, and are exceptionally pleasant and comfortable places to sit or lay.

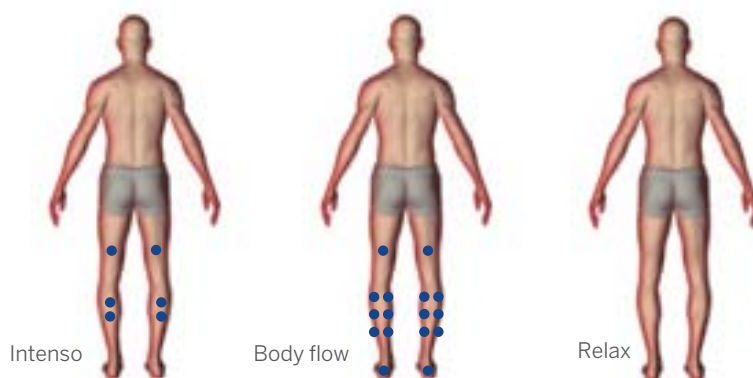



Seduta Intenso
Intenso seat

Il punto di massaggio più tonificante. Atleti professionisti, appassionati di sport e tutti coloro in cerca di intenso idromassaggio potranno godere dell'esperienza maturata con la seduta Intenso.

The most invigorating massage spot. Professional athletes, sport fans and anyone looking for intense hydro massage will enjoy the experience provided by Intenso seat.

Seduta Body flow
Body flow seat

Questa lounge massaggio terapeutico design ergonomico offre comfort di lusso, mentre i suoi getti accuratamente posizionati forniscono un'esperienza di massaggio superiore per tutto il corpo.

This ergonomically designed therapeutic massage lounge provides luxurious comfort, whilst its carefully placed jets provide a superior massage experience for the entire body.

Seduta Relax
Relax seat

I numerosi getti di questo straordinario sedile massaggio per il corpo sono accuratamente posizionati per massaggiare il collo, le spalle, polpacci e piedi.

The numerous jets of this extraordinary body massage seat are carefully positioned to massage your neck, shoulders, calves and feet.



FILTRAZIONE DELL'ACQUA, GENERATORE DI OZONO

Water filtration, ozone generator

WELLIS sistema di filtraggio a più livelli e la pulizia dell'acqua è progettato per fornire acqua pulita spa cristallo eccezionale qualità.

Il nostro sistema di filtraggio e di pulizia dell'acqua multi-livello è stato progettato per fornire, acqua termale sicura chiara, priva di tutti i contaminanti. Mentre vi rilassate, oli per il corpo e altri contaminanti vengono rimossi da grandi filtri a cartuccia capacità che assicurano il 100% di filtrazione dell'acqua molte volte al giorno. Per semplice sistema filtri manutenzione possono essere facilmente prelevati e sostituiti.

WELLIS multi-level filtering and water cleaning system is designed to provide exceptionally high quality crystal clear spa water. Our multi-level filtering and water cleaning system was designed to provide clear, safe spa water, free of all contaminants. While you relax, body oils and other contaminants are removed by large capacity cartridge filters that ensure 100% filtration of the water many times each day. For simple system maintenance filters can be easily taken out and replaced.

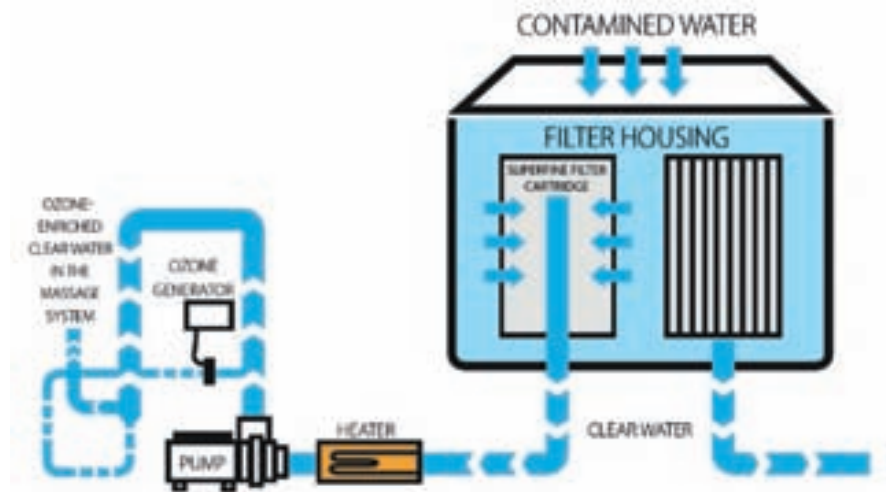

COLOUR THERAPY

Colour therapy mood lighting

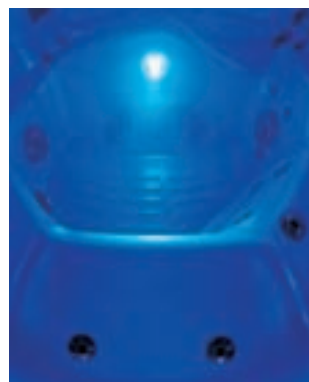
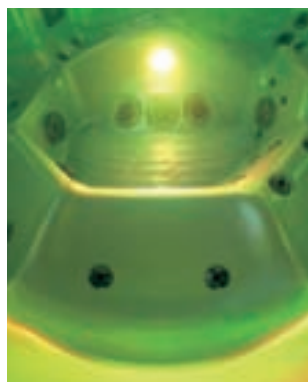

Stato della depressione
stress, reumatismi
febbre costipazione
problemi asmatici

State of depression
stress, rheumatism
fever constipation
asthmatic problems

Insomnia cronica problemi
di cuore, stato mentale
turbato irritazioni cutanee la
pressione alta

Chronic insomnia heart
problems, upset mental
state skin irritations high
blood pressure

Problemi di digestione
la stanchezza, la depressione
influenza diabete, raffreddori
depressione cronica

Digestion problems
weariness, depression
diabetes flu, colds
chronic depression

Rilievo di crampi mestruali
funzione di gola e ghiandole
ritmo cardiaco, polso
mal di testa, mal di denti

Relief of menstrual cramps
function of throat and glands
heart rhythm, pulse
headache, toothache

Modello / Model	Ozone	UV-C	Filtro / Filter housing
Dream	√		
Dream plus		√	
Country		√	
Country plus		√	
Avenue		√	
Avenue plus		√	
Sun			√
Sun plus	√		



TUTTA L'EMOZIONE DELL'ACQUA E DEL COMFORT

Dream Sun Country Avenue

Quattro modelli con dimensioni, numero di sedute e allestimenti diversi per rispondere a ogni esigenza. Il rivestimento in polimerico composito, elegante nel colore grigio, assicura una totale resistenza ai raggi UV, all'acqua, ai graffi e alle ammaccature. Le linee sono sempre avvolgenti per dare il massimo del comfort.

All the pleasure of water and comfort combined

Four models differing in size, number of seats and features, to meet every need. The elegant grey-coloured cabinet is made from an UV resistant polymer that look as real wood but is completely maintenance free. Maximum comfort is provided by the enfolding lines of the range.



Dream: minipiscina da esterno 230x230x 93H,
6 posti, idromassaggio tonificante, cromoterapia,
ozonoterapia: massimo relax garantito.

Dream: hot tub, 230x230, 6 places, hydromassage,
cromotherapy, ozonotherapy: we guarantee maximum relax.

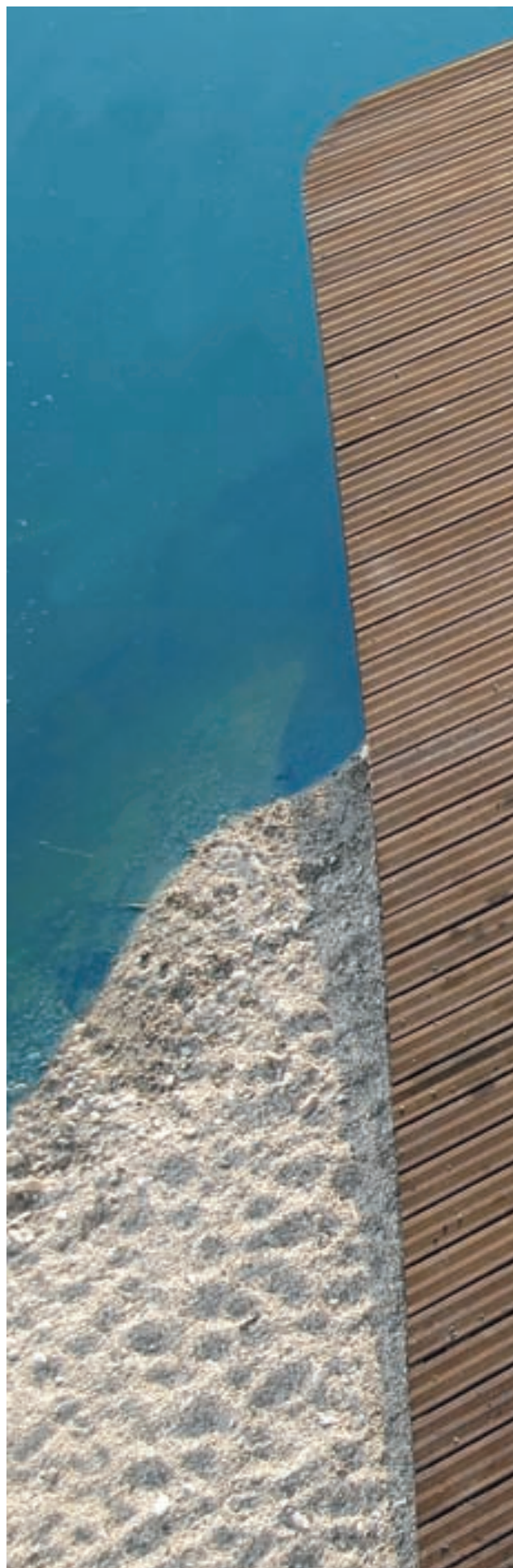



DREAM
230 x 230 x 97 h

In ogni modello, il diverso numero di jet è studiato per dare alle varie postazioni specifiche esperienze di massaggio, con sempre una seduta reclinata per concedersi un trattamento completo e speciale. Nelle minipiscine dal design elegante e funzionale, ci s'immerge nella sprizzante vivacità dell'acqua unendo relax, benessere e divertimento.

In every model, the different number of jets is devised to provide each seat with a specific massage experience, with a reclined seat at all times for a complete and special treatment. In these stylishly designed and functional mini-pools, soak in gurgling and bubbling water for combined relaxation, well-being and fun.



COUNTRY

218 x 218 x 91 h





SUN

213 x 160 x 75 h



AVENUE

200 x 200 x 91 h

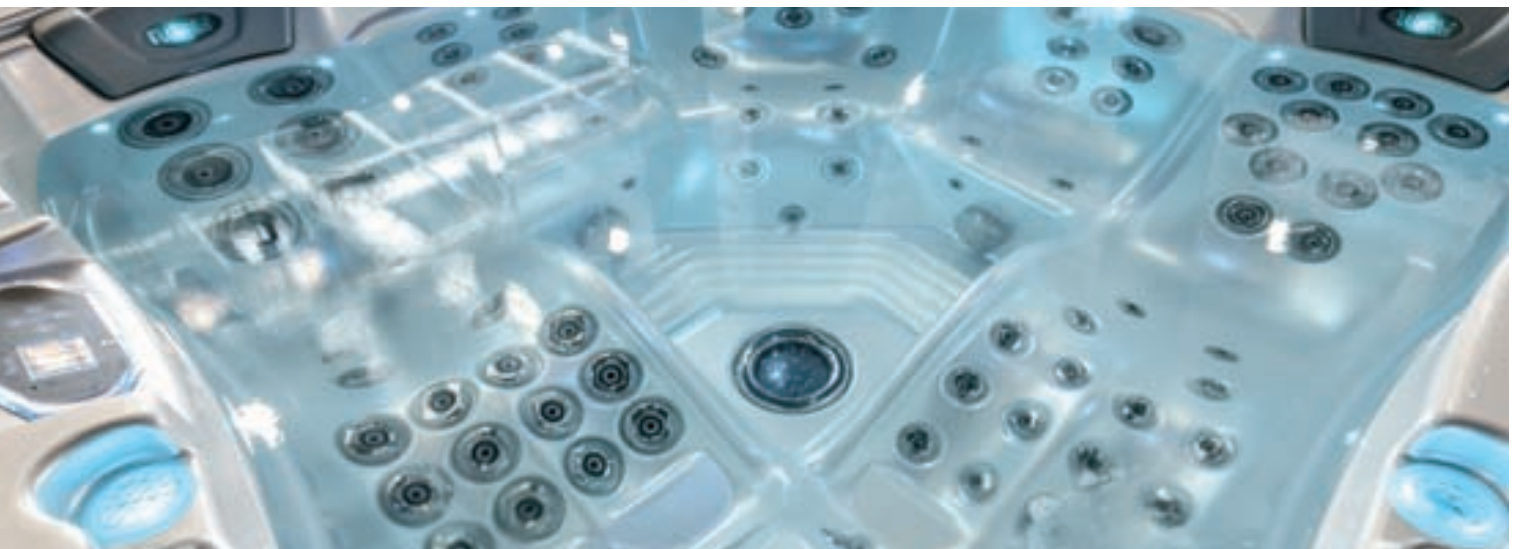

BOX DOCCIA MULTIFUNZIONE

✓ Multifunctions shower cabins

page 192
Talos Plus

page 200
Tempo curvo

page 204
Tempo

page 210
Soul

page 216
Sound

page 222
New Bi-Size

IDROTERAPIA NELLA CABINA MULTIFUNZIONE

Hydrotherapy in the multifunctional cabin

La ricerca Hafro ha portato la doccia in una nuova dimensione. Attorno all'acqua, modulata secondo vari effetti, lo studio di tutto ciò che può aumentare il benessere del corpo e della mente ha creato un vero ambiente multisensoriale con luci, aromi, suoni. Il design ha integrato in forme moderne ed eleganti materiali e dispositivi per dare la più piacevole delle sensazioni anche a prima vista, e il massimo del comfort.

Hafro's research has taken the shower to another dimension. Based around water, modulated through different effects, research into everything that can increase wellness of body and mind has created a true multisensory environment with lights, aromas and sounds. The design has integrated materials and devices in modern, elegant shapes to give you the most pleasurable of sensations even at a glance, and maximum comfort.

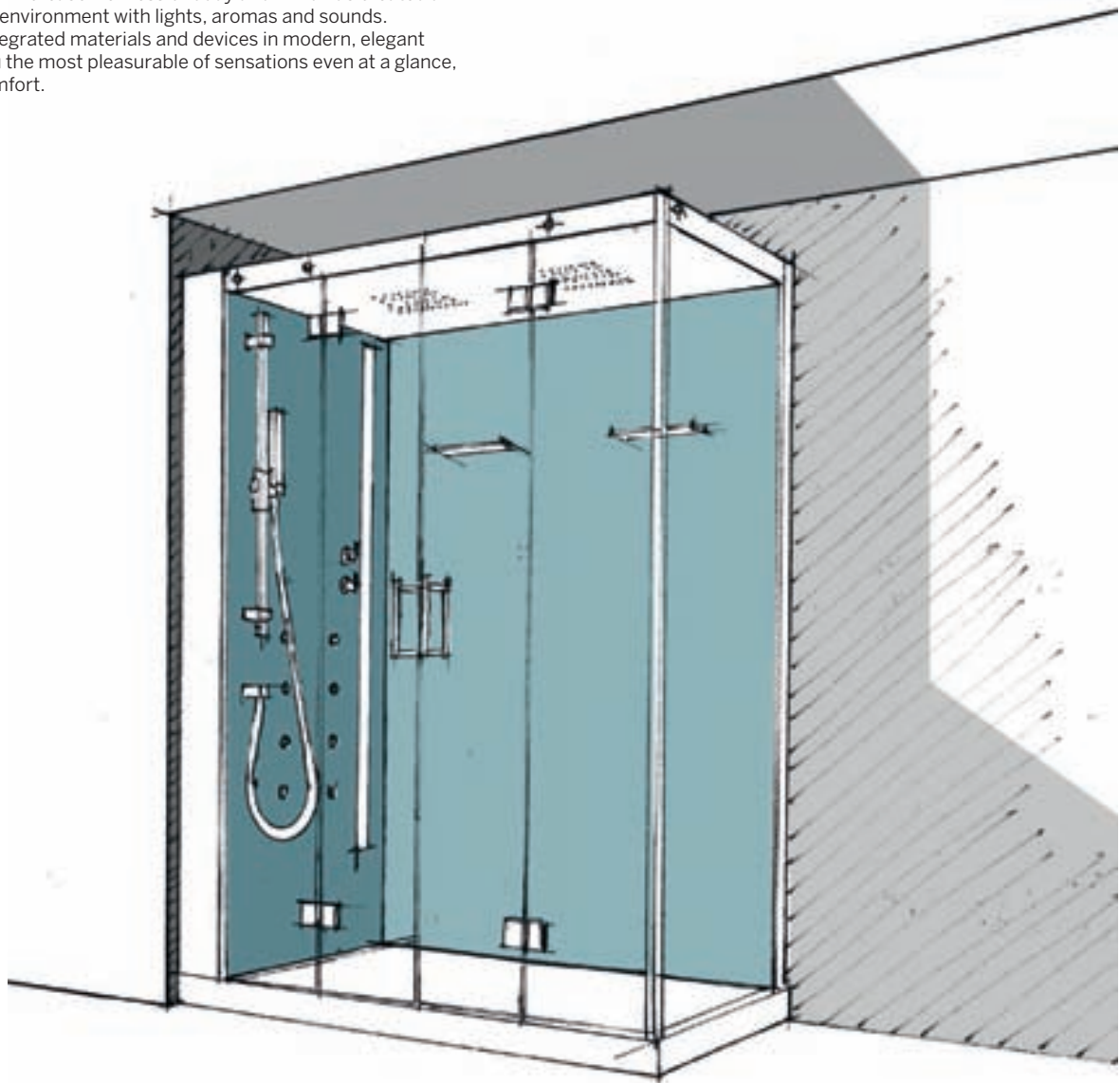

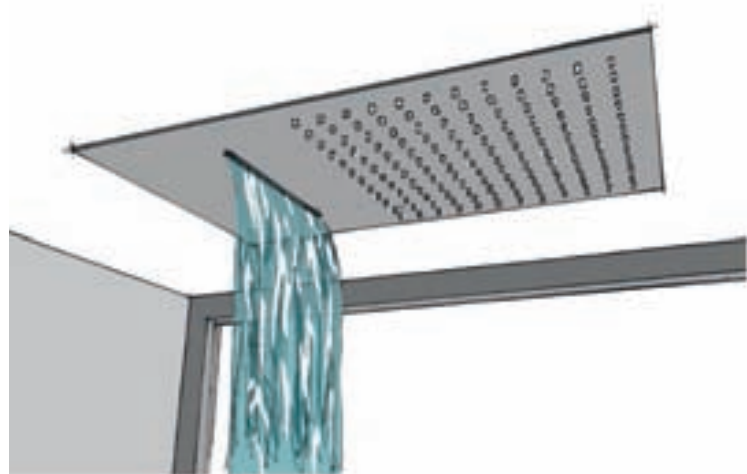
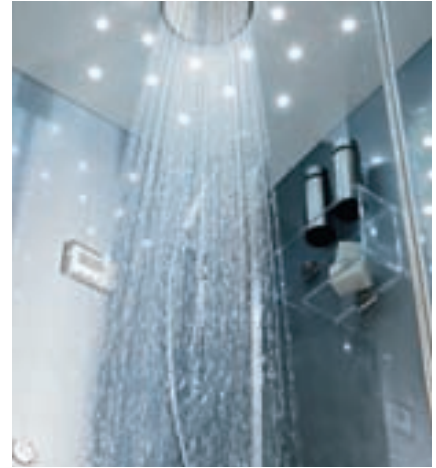
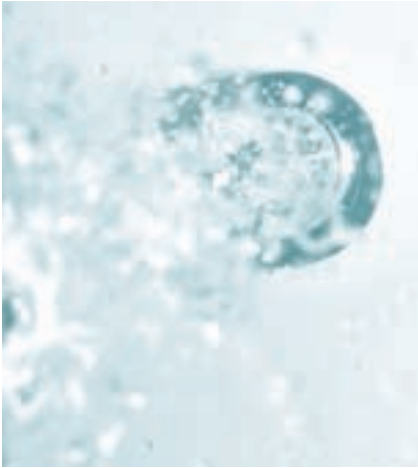

TALOS

L'eleganza dei profili e del tetto in acciaio e del cristallo da 8 mm, l'estetica delle pareti attrezzate in cristallo di sicurezza e l'esclusività di un allestimento al top di gamma con touch screen.

The elegance of the steel edges and roof and the 8 mm thick glass, the beauty of the walls fitted with safety glass and the exclusive top-of-the-range fittings with touch screen.

BRISTOL

Il piacere dell'essenzialità con pareti in cristallo da 8 mm, anche in versione singola, colonna integrata multifunzione in acciaio lucido e piatto anche a filo pavimento.

The pleasure of simplicity with 8 mm thick glass walls, in a single version too, with integral polished steel column, and base also flush with floor.

TEMPO

Il fascino del design con profili in alluminio piatto e cristalli da 8 mm, e un allestimento wellness completo con display LCD per un ambiente di comfort e bellezza, anche in versione curva.

The charm of the design with flat aluminium edges and 8 mm thick glass panels, and a complete wellness fitting with LCD display for a beautiful, comfortable space, also in a curved version.

SOUND

Tetto e piatto in acrilico con profili cromati e cristalli da 6 mm, colonna ad angolo anche in versione con idromassaggio e allestimenti diversi per scegliere un comfort personalizzato.

Acrylic roof and base with chrome edges and 6 mm thick glass panels, corner column also in a version with hydromassage and different fittings to offer personalised comfort.

SOUL

Il candore delle pareti bianche e la trasparenza del cristallo da 8 mm con profili cromati, e un allestimento wellness con telecomando estraibile racchiudono sensazioni uniche.

The purity of the white walls and transparency of the 8 mm thick glass with chrome edges, and a wellness fitting with a pull-out remote control, enfolds you in unique sensations.

NEW BI-SIZE

Cabina multifunzione con tetto e parete attrezzata, cristalli da 6 mm con profili in alluminio, apertura scorrevole ad angolo tondo in tre misure e due allestimenti wellness.

Multifunctional cabin with roof and fitted wall, 6 mm thick glass panels with aluminium edges, rounded corner sliding door in three sizes and with two different wellness fittings.

LASCIATI AVVOLGERE DA UN MONDO DI MERAVI GLIOSE SENSAZIONI

Indulge in a world of wonderful
sensations

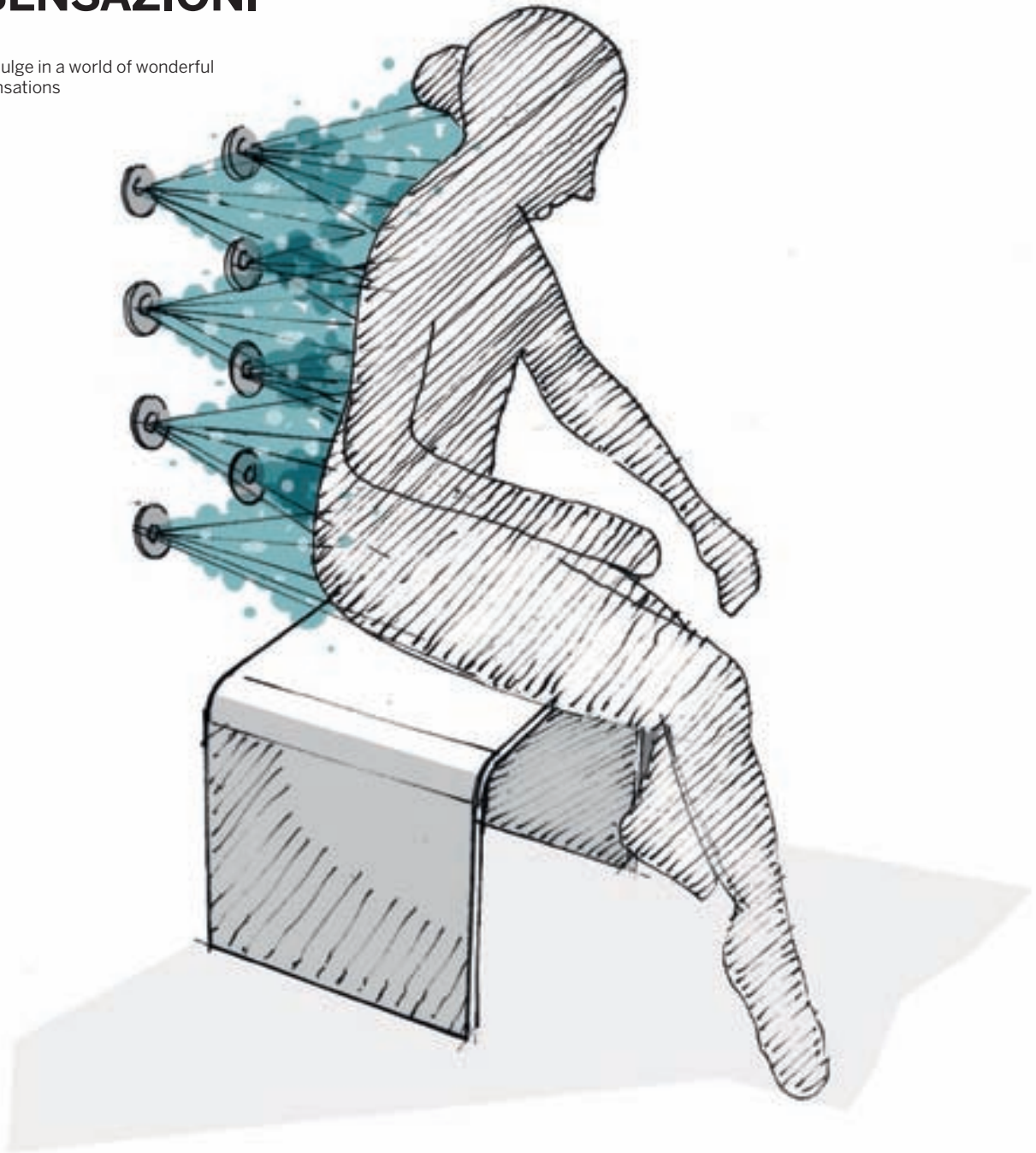



I MASSAGGI MASSAGES

Jets orientabili / Jets adjustable

L'acqua è un elemento straordinario. Sapientemente veicolata dai jets posizionati secondo un progetto preciso, agisce sui muscoli eliminando le tensioni e restituendo forza e vitalità. Il massaggio d'acqua di Hafro è il tuo incontro quotidiano con il benessere.

Water is an extraordinary element. Cleverly funnelled by jets positioned according to an exact plan, it works on your muscles to get rid of tension and restore strength and vitality. Hafro's water massage is your daily encounter with wellness.

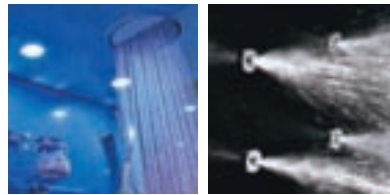

Cromoterapia / Chrome therapy

Agisce sull'organismo mediante l'azione della luce irradiata da appositi faretti. Le diverse frequenze e lunghezze d'onda che ne determinano il colore, rosso, verde, giallo, blu, agiscono a livello cellulare mediante il fenomeno della risonanza favorendo la stimolazione o il rilassamento. Insonnia, stress, dermatiti, disturbi respiratori e digestivi possono trovare giovamento da tali applicazioni.

It acts on the organism through the beneficent action of the green, blue, red and yellow light radiated from special spots. The different frequencies and wavelengths, that determine the colors, directly act to cellular level through the phenomenon of the resonance. The effect of equilibrium is very important and favours both stimulation and relax according to the color. Insomnia, stress, dermatitises, respiratory and digestive troubles can find an immediate relief.



IL BAGNO DI VAPORE THE STEAM BATH

Aroma therapy

L'utilizzo degli aromi allo scopo di indurre particolari sensazioni è pratica antica ed universalmente diffusa: il profumo dei fiori, gli oli essenziali. Una armonica composizione di profumi accompagna ciascun trattamento di benessere, creando l'ambiente più indicato per ottenere il meglio dall'azione energizzante, rilassante o balsamica che le essenze emanano dagli appositi diffusori.

The use of the aromas to the purpose to induce particular feelings is practical ancient and universally diffused: the perfume of the flowers, the essential oils. An harmonic composition of perfumes accompanies every treatment of comfort, creating the most suitable environment to get the best from the energizing, relaxing or balmy action given by the essences spread by the special diffusers.



Herbs therapy

Le erbe e le piante nell'idroterapia. Appositi dispositivi di erogazione permettono l'utilizzo di resine o di estratti vegetali i cui principi attivi vengono diffusi per potenziare, in modo specifico, ciascun trattamento di benessere, in perfetta armonia con la miglior tradizione del mantenimento della salute attraverso la natura. Il recupero di antiche conoscenze rese facilmente fruibili attraverso una tecnologia evoluta, sicura, flessibile.

Herbs and plants enter the world of the hydrotherapy. Special outlet devices allow the use of resins or vegetable extracts whose active ingredients are spread for strengthening, in specific way, every treatment of comfort, in perfect harmony with the good tradition of the maintenance of the health through the nature. The recovery of ancient knowledges is easily made enjoyable through a safe, flexible evolved technology.

Talos Plus

Cabina doccia multifunzione in cristallo e acciaio

Multifunction shower cabin in crystal glass and stainless steel

Dimensioni
105x80 dx-sx
160x80 dx-sx

Installazione
Angolo
Nicchia

Sistemi
Top Line

Colori
Bianco
Rosso Granato
Nero

Measurement
105x80 right-left
160x80 right-left

Installation
Corner
Niche

System
Top Line

Colour
White
Red
Black

Talos Plus 160x80 sx Top Line nero/black

- piatto doccia in solid surface con piletta e sifone
- pedana in solid surface
- mensole in solid surface
- pareti attrezzate in cristallo di sicurezza
- tetto in acciaio inox con soffione a pioggia
- chiusura con porta battente 8 mm
- Bagno Turco Kw 2,6 multiclimate
- rubinetteria termostatica
- asta doccia con doccetta
- 8 jets idromassaggio sequenziali con 3 funzioni: nebulizzante, pulsato e raining
- doccia scozzese
- nebulizzatore
- cascata a velo in acciaio
- radio
- USB/AUX
- display LCD
- aromaterapia e fitoterapia
- erogatore di vapore
- cromoterapia a led 42 colori
- allarme sonoro
- sistema di decalcificazione per caldaia
- manutenzione caldaia programmata
- trattamento anticalcare per cristalli

- solid surface shower tray with drain and siphon
- solid surface footboard
- solid surface holding shelves
- equipped safety crystal panels
- steel roof with headshowers rain effect
- leafed door 8 mm thick enclosure
- multiclimate steambath Kw 2,6
- thermostatic
- handshower on slide bar
- 8 sequential hydromassage jets with 3 functions: nebulizing, pulsed, raining
- scottish shower
- nebulizing
- veil cascade in steel
- radio
- USB/AUX
- LCD display
- aromatherapy and phitotherapy
- steam generator
- led colour therapy 42 colours
- alarm
- anti-dust system for boiler
- programmed boiler keeping
- tempered lime crystal

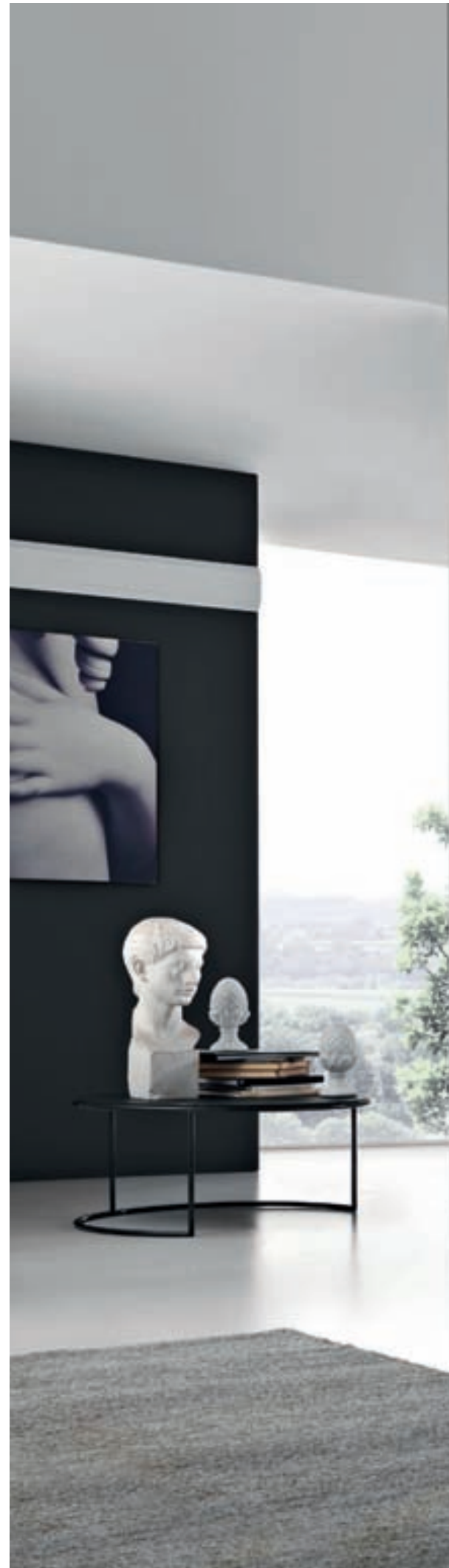



Talos Plus

Cabina doccia multifunzione in cristallo e acciaio

Multifunction shower cabin in crystal glass and stainless steel

Talos Plus Top Line 105X80 dx bianco/right white

- cabina doccia multifunzione in cristallo e acciaio
 - bagno turco 2 Kw
 - display LCD
 - pareti attrezzate in cristallo di sicurezza
 - chiusura con porta battente da 8 mm
 - rubinetteria termostatica
 - 8 jets idromassaggio
 - piatto doccia e pedana in solid surface
 - tetto in acciaio inox con soffione a pioggia
 - erogatore di vapore
 - aromaterapia e fitoterapia
 - mensola porta oggetti
 - cromoterapia a led 42 colori
 - radio
 - nebulizzatore
 - cascata a lama
 - USB/AUX
 - trattamento anticalcare per cristalli
-
- multifunction shower cabin made up by steel and crystal glass
 - steam bath 2 Kw
 - LCD display
 - equipped crystal glass walls
 - crystal glass shutter door enclosure
 - thermostatic tap
 - 8 hydromassage jets
 - steam generator
 - aromatherapy and phytotherapy
 - holding shelf
 - solid surface shower tray and footboard
 - stainless steel roof
 - led colour therapy 42 colours
 - radio
 - nebulizing
 - veil cascade
 - USB/AUX
 - tempered lime crystal



Talos Plus

Cabina doccia multifunzione in cristallo e acciaio

Multifunction shower cabin in crystal glass and stainless steel

Dimensioni
160x80 dx-sx

Installazione
Nicchia

Sistemi
Top Line

Colori
Nero

Measurement
160x80 right-left

Installation
Niche

System
Top Line

Colour
Black





TECNOLOGIA E COMFORT

Technology and comfort

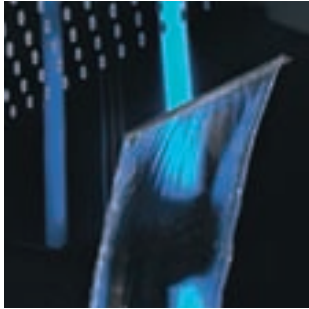

La cascata di Talos Plus crea l'effetto di una lama sottile ed energica che consente all'acqua di regalare un'esclusiva sensazione.

Talos Plus cascade creates a water blade to give an exclusive feeling.

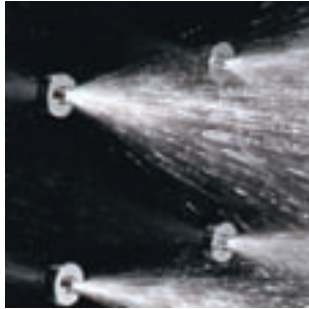

L'idromassaggio sequenziale è stato potenziato con 8 getti verticali per una più efficace azione lombare e cervicale.

The sequential hydro-massage has been enhanced with 8 vertical jets for a more effective back and neck action.

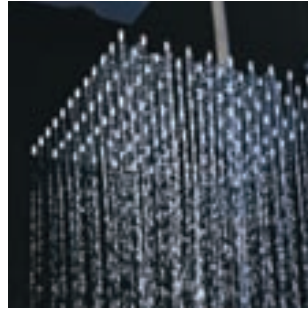

I due soffioni sono integrati nel tetto in acciaio inox. La funzionalità a pioggia amplifica la sensazione dell'acqua.

Two built in roof stainless steel shower heads amplify water sensation.



Il display per il controllo delle funzioni da 7,5 pollici consente un'ottima visibilità con la praticità della tastiera touch screen.

7.5" touch screen display controls every function.



La funzione bagno turco utilizza un erogatore di vapore perfettamente dimensionato all'ambiente doccia.

Steam bath is available thanks to the steam generator.



La vasta gamma di sgabelli permette di godere il bagno di vapore, in assoluta comodità, trasformando il box in un piccolo hammam.

Wide range of seats allows you to benefit by a steam bath for 2 people, in complete comfort, converting the shower box in a small hammam.



In doccia con il tuo iPod. Anche sotto l'acqua puoi rimanere in compagnia delle tue canzoni preferite grazie alle entrate jack e USB integrate.

A shower with your iPod. Even under the water it's possible to remain together with your favourite songs thanks to the built-in jack e USB.



La funzione della cromoterapia è affidata ai led integrati nella parete in cristallo per colorare la doccia di benessere.

The function of colour therapy is entrusted to the led integrated into the glass wall to paint the shower of well-being.

INSTALLAZIONI

Installations

Talos Plus Top Line 105

Cabina doccia multifunzione in cristallo e acciaio completa di Bagno Turco multiclimate Kw 2 - display LCD - pareti attrezzate in cristallo di sicurezza - chiusura con porta battente 8 mm - rubinetteria termostatica - asta doccia con doccetta - nr. 8 jets idromassaggio sequenziali - doccia scozzese - erogatore di vapore con aromaterapia e fitoterapia - manutenzione caldaia programmata - sistema di decalcificazione per caldaia - allarme sonoro - mensola porta oggetti - piatto doccia in solid surface con piletta e sifone - pedana in solid surface - tetto in acciaio inox con soffione a pioggia - cromoterapia - radio - nebulizzatore - cascata a lama - USB/AUX

Multifunction shower cabin in crystal and steel - equipped with multiclimate steambath Kw 2 - LCD - equipped safety crystal panels - enclosure with leafed door 8 mm - thermostatic tap - handshower on slide bar - nr. 8 sequential hydromassage jets - scottish shower - steam dispenser with aromatherapy and phitotherapy - programmed boiler keeping - anti-dust system for boiler - alarm - holding crystal shelf - solid surface shower tray with drain and siphon - steel roof with headshower rain effect - chrome-therapy - solid surface footboard - radio - nebulizer - veil cascade - aux/usb

Talos Plus Top Line 160

Cabina doccia multifunzione in cristallo e acciaio completa di Bagno Turco multiclimate Kw 2,6 - display LCD - pareti attrezzate in cristallo di sicurezza - chiusura con porta battente 8 mm - rubinetteria termostatica - asta doccia con doccetta - nr. 8 jets idromassaggio sequenziali con 3 funzioni: nebulizzante, pulsato e raining - doccia scozzese - erogatore di vapore con aromaterapia e fitoterapia - manutenzione caldaia programmata - sistema di decalcificazione per caldaia - allarme sonoro - 2 mensole porta oggetti - piatto doccia in solid surface con piletta e sifone - pedana in solid surface - tetto in acciaio inox con 2 soffioni a pioggia - cromoterapia - radio - nebulizzatore - cascata a lama - USB/AUX

Multifunction shower cabin in crystal and steel - equipped with multiclimate steambath Kw 2,6 - LCD - equipped safety crystal panels - enclosure with leafed door 8 mm - thermostatic tap - handshower on slide bar - nr. 8 sequential hydromassage jets - scottish shower - steam dispenser with aromatherapy and phitotherapy - programmed boiler keeping - anti-dust system for boiler - alarm - holding crystal shelf - solid surface shower tray with drain and siphon - steel roof with headshower rain effect - chrome-therapy - solid surface footboard - radio - nebulizer - veil cascade - aux/usb

Colori pareti box / Box panels colors



Angolo/Corner

SX / L

DX / R

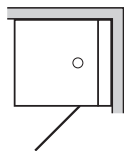
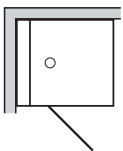

105x80

SX / L

DX / R

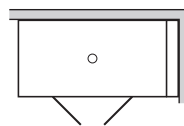
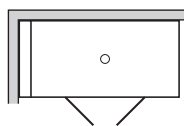

160x80

Nicchia/Niche

SX / L

DX / R

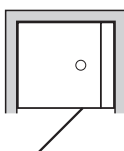
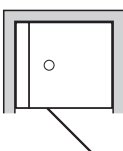

105x80

SX / L

DX / R

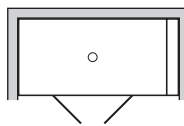
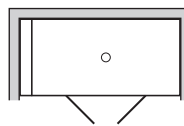

160x80

Tempo Curvo

Cabina doccia multifunzione in cristallo e acciaio

Multifunction shower cabin in crystal glass and stainless steel

Dimensioni

90x90 dx-sx
100x90 dx-sx
120x80 dx-sx
100x100 dx-sx

Installazione

Angolo

Sistemi

Integra - Junior

Colori

Bianco
Ruggine
Rosso Granato
Blu oltremare
Moka
Grigio
Nero

Measurement

90x90 right-left
100x90 right-left
120x80 right-left
100x100 right-left

Installation

Corner

System

Integra - Junior

Colour

White
Orange Rust
Red
Blue
Moka
Grey
Black

Tempo Junior Angolo Curvo 90X90 sx Grigio Tempo Junior Round 90X90 Left Grey

- piatto doccia solid surface con piletta
- chiusura (con porta battente) in cristallo di sicurezza 8 mm
- tetto con soffione centrale raining
- mensola porta oggetti
- specchio
- luce
- radio con collegamento iPod
- display LCD
- Bagno Turco con selezione temperatura da Kw 2
- 6 jets idromassaggio sequenziali con 3 funzioni: nebulizzante, pulsato e raining
- erogatore vapore con aromaterapia e fitoterapia
- doccia scozzese
- miscelatore termostatico
- asta doccia con doccetta
- allarme
- sistema di decalcificazione per caldaia
- manutenzione caldaia programmata
- trattamento anticalcare per cristalli
- solid surface shower tray with drain
- safety crystal glass enclosure with leafed door 8mm
- roof with headshower rain effect
- holding shelf
- mirror
- light
- radio with iPod connection
- LCD display
- steambath with temperature control 2 Kw
- 6 sequential hydromassage jets with 3 functions: nebulizing, pulsed, raining
- steam generator
- scottish shower
- thermostatic tap
- handshower on slide bar
- alarm
- anti-dust system for boiler
- programmed boiler keeping
- aromatherapy and phitotherapy
- tempered lime crystal







UNA DOCCIA SOTTO LE STELLE

A shower under the stars

L'illuminazione è realizzata in modo scenografico: una serie di faretto distribuiti sul tetto crea questa spettacolare opzione per la cromoterapia disponibile in tutti i modelli Tempo. E' uno dei tanti particolari di pregio, come il display digitale, la mensola porta oggetti a due livelli e il seggiolino arrotondato in acrilico trasparente. Il confort raggiunge livelli di eccellenza, unendo tecnica e design.

The illumination is realized as a set design: a series of micro-spots distributed on the roof creates this spectacular option for the chrome therapy available in every version of Tempo. It is just one of the details of merit as the digital display, the two levels object holder shelf and the transparent acrylic seat rounded. The confort reaches levels of excellence matching technique and design.



Display digitale con pulsanti.
Digital Display with buttons.



Mensola sagomata in acrilico trasparente.
Shaped shelf in transparent acrylic.



Sgabello in acrilico trasparente su pedana
in laminato ad alta pressione (HPL).

Transparent acrylic seat on high
pressure laminate footboard (HPL).

Tempo

Cabina doccia multifunzione in cristallo e acciaio

Multifunction shower cabin in crystal glass and stainless steel

Dimensioni

90x80 dx-sx
90x90 dx-sx
100x80 dx-sx
100x90 dx-sx
120x80 dx-sx
100x100 dx-sx

Installazione

Angolo - Nicchia

Sistemi

Integra - Junior

Colori

Bianco
Ruggine
Rosso Granato
Blu oltremare
Moka
Grigio
Nero
Nero damascato

Measurement

90x80 right-left
90x90 right-left
100x80 right-left
100x90 right-left
120x80 right-left
100x100 right-left

Installation

Corner - Niche

System

Integra - Junior

Colour

White
Orange Rust
Red
Blue
Moka
Grey
Black
Black damasked

Tempo Junior Angolo 120X80 sx nero Tempo Junior Corner 120X80 left black

- piatto doccia solid surface con piletta
- chiusura (con porta battente) in cristallo di sicurezza 8 mm
- tetto con soffione centrale raining
- mensola porta oggetti
- specchio
- luce
- radio con collegamento iPod
- display LCD
- bagno Turco con selezione temperatura da Kw 2
- 6 jets idromassaggio sequenziali con 3 funzioni: nebulizzante, pulsato e raining
- erogatore vapore con aromaterapia e fitoterapia
- doccia scozzese
- miscelatore termostatico
- asta doccia con doccetta
- allarme
- sistema di decalcificazione per caldaia
- manutenzione caldaia programmata
- trattamento anticalcare per cristalli

- solid surface shower tray with drain
- safety crystal enclosure with leafed door 8mm
- roof with headshower rain effect
- holding shelf
- mirror
- light
- radio with iPod connection
- LCD display
- steambath with temperature control 2 Kw
- 6 sequential hydromassage jets with 3 functions: nebulizing, pulsed, raining
- steam generator
- scottish shower
- thermostatic tap
- handshower on slide bar
- alarm
- anti-dust system for boiler
- programmed boiler keeping
- aromatherapy and phytotherapy
- tempered lime crystal







LA CROMOTERAPIA

Colour therapy

La luce colorata ha una diretta influenza sullo stato d'animo. La sua lunghezza d'onda, opportunamente veicolata, penetra nella pelle favorendo le funzioni biologiche e il riequilibrio psico fisico. L'associazione alle altre tecniche come l'idromassaggio o il bagno turco completa l'approccio Hafro al benessere.

Coloured light has a direct influence on state of mind. Its wavelength, it penetrates in the skin favouring the biological functions and the psycho- physical equilibrium. The association to the other techniques as the hydromassage or the turkish bath completes Hafro approach to comfort.

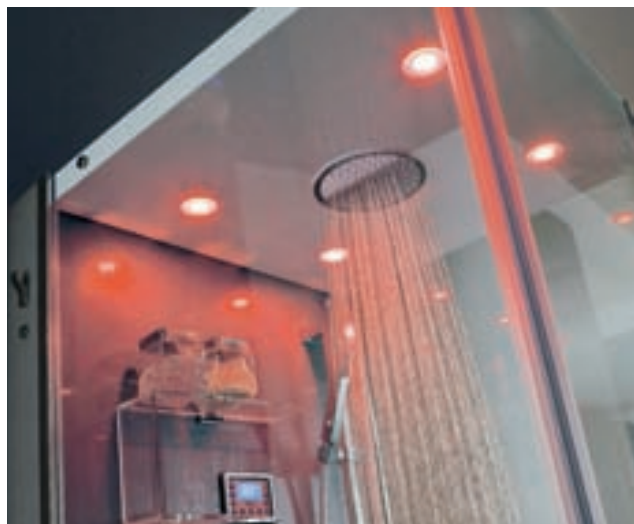

SEDILE

Seat

Che abbia la trasparenza del plexiglas, la lucentezza del metallo e la delicatezza del corian, il seggiolino è un elemento fondamentale per il comfort del box doccia con idromassaggio o bagno turco. Le posizione seduta consente di apprezzare al meglio le straordinarie virtù di questo box.

Whatever the transparency of the plexiglas or the brightness of the metal, the seat is a fundamental element for the comfort of the shower cabin with hydromassage or steam bath. The sitting position allows to appreciate to the best the extraordinary virtues of this cabin.

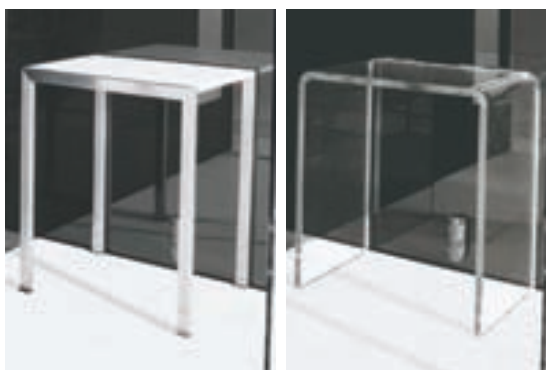

GLI ACCESSORI

Accessories

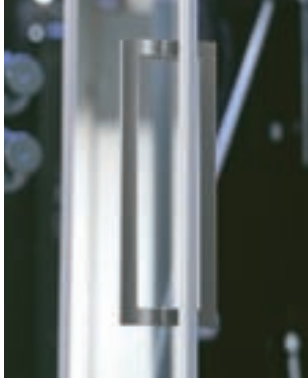

Maniglia Handle

La maniglia metallica è un brillante esempio di equilibrio tra forma e funzione. In linea con l'estetica dal gusto tecnico, crea con l'essenzialità del rigore geometrico una facile apertura.

Metallic handle it is a smart example of equilibrium between shape and usability. Besides the technical shape creates an easy opening together with the geometric exactness.



Rubinetteria termostatica Thermostatic tap

La forma dei rubinetti termostatici è una vera stilizzazione geometrica. In due semplici cilindri cromati è racchiusa la capacità di regolare l'acqua. Il design si esprime in ogni dettaglio.

The particular shape of thermostatic faucets is a true geometric stylization. In two simple chromed cylinders is contained the ability to regulate the water. Design is expressed in every single details.

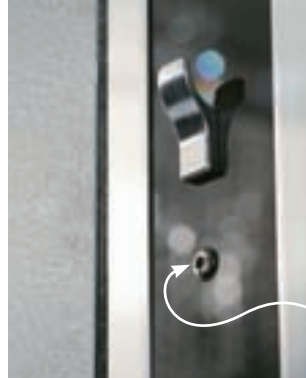

Appendi abiti e connessione i-pod Towel hook with i-pod plug

In doccia con il tuo iPod. Anche sotto l'acqua puoi rimanere in compagnia delle tue canzoni preferite grazie alla presa jack integrata, posta sotto l'appendi abiti cromato.

A shower with your iPod. Even under the water it's possible remain together with your favourite songs thanks to the built-in jack, under the chromed towel hanger.



Colori pareti box / Box panels colors



Rosso Granata
Red



Moka



Bianco
White



Grigio
Grey



Ruggine
Orange Rust



Blu Oltremare
Oversea Blue



Nero
Black

INSTALLAZIONI

Installations

Integra

Cabina doccia multifunzione - miscelatore termostatico - asta doccia con doccetta - nr. 6 jets idromassaggio con 3 funzioni: nebulizzante, pulsato e raining - tetto con soffione centrale raining - mensola porta oggetti - specchio - piatto doccia solid surface con piletta - chiusura (con porta battente) in cristallo di sicurezza 8 mm

Multifunction shower cabin - thermostatic tap - handshower on slide bar - nr. 6 hydromassage jets with 3 functions: nebulizing, pulsed, raining - built-in roof headshower rain effect - holding shelf - mirror - solid surface shower tray with drain - safety crystal glass enclosure with leafed door 8mm

Junior

Cabina doccia multifunzione - completa di Bagno Turco con selezione temperatura da Kw 2 - display LCD - erogatore vapore con aromaterapia e fitoterapia - manutenzione caldaia programmata - allarme - sistema di decalcificazione per caldaia - doccia scozzese - miscelatore termostatico - asta doccia con doccetta - nr. 6 jets idromassaggio sequenziali con 3 funzioni: nebulizzante, pulsato e raining - tetto con soffione centrale raining - mensola porta oggetti - specchio - piatto doccia solid surface con piletta - chiusura (con porta battente) in cristallo di sicurezza 8 mm - luce - radio con collegamento iPod

Multifunction shower cabin - complete with steam bath with temperature control 2 Kw - LCD - steam generator with aromatherapy and phytotherapy - programmed boiler keeping alarm - anti-dust system for boiler - scottish shower - handshower on slide bar - nr. 6 sequential hydromassage jets with 3 functions: nebulizing, pulsed, raining - built-in rain effect - holding shelf - mirror - solid surface shower tray with drain - safety crystal glass enclosure with leafed door 8mm - light - radio with iPod connection

apertura frontale
open front

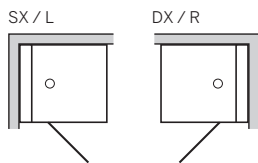

80x90 | 90x90 | 100x80
100x90 | 120x80 | 100x100

apertura frontale laterale
open front - side

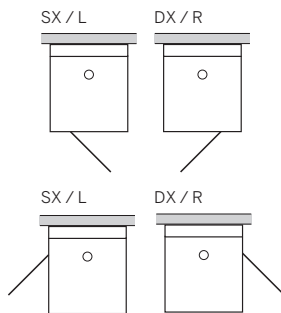

90x80 | 90x90

apertura frontale
open front

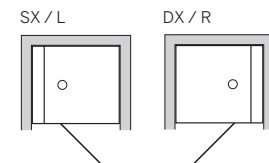

90x80 | 90x90 | 100x80
100x90 | 120x80 | 100x100

apertura laterale
open side

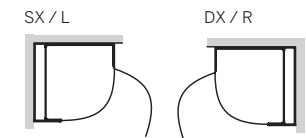

90x80 | 100x90 | 100x100
120x80

Soul Soul Stone

Cabina doccia multifunzione in cristallo e acciaio

Multifunction shower cabin in crystal
glass and stainless steel

Dimensioni
100x70 dx-sx
120x70 dx-sx
140x70 dx-sx

100x80 dx-sx
120x80 dx-sx
140x80 dx-sx

100x90 dx-sx
120x90 dx-sx
140x90 dx-sx

Installazione
Angolo - Nicchia

Sistemi
Integra - Junior

Colori
Bianco opaco
con vano tecnico
in finitura antracite

Altezza piatto
H. 8 cm - H. 14 cm

Measurement
100x70 right-left
120x70 right-left
140x70 right-left

100x80 right-left
120x80 right-left
140x80 right-left

100x90 right-left
120x90 right-left
140x90 right-left

Installation
Corner - Niche

System
Integra - Junior

Colour
matt white
with dry
in anthracite finish

Shower tray height
8 cm H. - 14 cm H.

Soul 120x80 sx Junior bianco
Piatto doccia H 8 cm
Soul 120x80 left Junior white
Shower tray 8 cm height

- telecomando
- piatto doccia stone grigio antracite con piletta e sifone
- tetto con soffione a pioggia
- chiusura con porta scorrevole 8 mm
- ripiano porta oggetti
- luce
- radio
- bagno Turco multiclimate
- display
- miscelatore
- soffioni verticali
- erogatore di vapore con aromaterapia e fitoterapia
- allarme sonoro
- sistema di decalcificazione per caldaia
- manutenzione caldaia programmata

- remote control
- charcoal gray stone shower tray with waste and siphon
- headshower built-in stainless steel roof
- leafed door 8 mm thick inclosure
- holding shelf
- light
- radio
- multiclimate steambath
- display
- mixer tap
- vertical jets
- steam generator
- alarm
- anti-dust system for boiler
- programmed boiler keeping
- aromatherapy and phitotherapy





Soul

Soul 100X90 sx Junior bianco / Soul 100X90 left Junior white
Piatto doccia / Shower tray 14 cm height





DISPOSITIVI E DOTAZIONI

Devices and equipment

Cristalli temperati circondati da un profilo cromato.
L'effetto del soffione centrale potenziato da due soffioni verticali.
In 120 per 80 cm ci sono il piacere e l'eleganza.

Crystal glass with chromed profile. central head shower
is powered by two vertical jets.
Comfort and elegange in a beautiful shower cabin.



Telecomando
Remote Control

Tastiera estraibile per il controllo delle funzioni radio, cromoterapia e bagno turco.

Retractable keyboard to control of radio functions, color therapy, and steam bath.



Cromoterapia
Colour Therapy

L'ambiente si colora di luce per potenziare l'effetto rigenerante della doccia.

The space get colored by light to enhance the effect of rejuvenating shower.



Piatto doccia H 8 cm
Shower tray 8 cm H



Piatto doccia H 14 cm
Shower tray 14 cm H

SOUL



Superficie piatto: Bianco lucido
Shower tray: Glossy white



Colori pareti box : Bianco lucido
Finishes: Glossy white

SOUL STONE



Superficie piatto: Finitura pietra
Shower tray: Stone finishing



Colori pareti box : Bianco opaco
Finishes: Matt white

INSTALLAZIONI

Installations

Integra - piatto 8 / 14 cm

Cabina doccia multifunzione - miscelatore - doccetta
 - soffioni verticali - tetto con soffione centrale raining
 - mensola porta oggetti - piatto doccia con piletta cromata
 - chiusura (con porta scorrevole) in cristallo di sicurezza 8 mm
 - pannello piatto H 8 (prevedere incasso per piletta) /14 cm

Multifunction shower cabin - mixer tap - hand shower
 - vertical jets - built-in roof head shower - holding shelf
 - sliding door crystal glass encloser 8 mm thick
 - shower tray 8 (encased drain required) / 14 cm H

Junior - piatto 8 / 14 cm

Cabina doccia multifunzione - completa di Bagno Turco
 con selezione temperatura - display - erogatore vapore
 con aromaterapia e fitoterapia - manutenzione caldaia
 programmata - allarme - sistema di decalcificazione per
 caldaia - miscelatore - doccetta - soffioni verticali - tetto
 con soffione centrale raining - mensola porta oggetti
 - piatto doccia con piletta cromata - chiusura (con porta scorrevole)
 in cristallo di sicurezza 8 mm - luce - pannello piatto H 8 (prevedere
 incasso per piletta) /14 cm - display - telecomando - radio

Multifunction shower cabin - mixer tap - hand shower
 - vertical jets - built-in roof head shower - holding shelf
 - sliding door crystal glass encloser 8 mm thick
 - shower tray 8 (encased drain required) / 14 cm H - multifunction
 shower cabin equipped with steam bath with temperature control
 - programmed boiler keeping - alarm - anti dust system
 - display - remote control - radio

Angolo/Corner

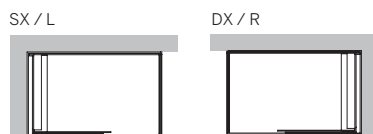

100x70		100x80		100x90
120x70		120x80		120x90
140x70		140x80		140x90

Nicchia/Niche

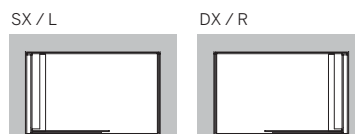

100x70		100x80		100x90
120x70		120x80		120x90
140x70		140x80		140x90

Sound

/ Design **Franco Bertoli**

Cabina doccia multifunzione in cristallo e acciaio

Multifunction shower cabin in crystal glass and stainless steel

Dimensioni

80x80 dx-sx
90x90 dx-sx
90x90 tondo
90x70 dx-sx
100x70 dx-sx
100x80 dx-sx
120x80 dx-sx

Installazione

Angolo

Sistemi

Step - Integra
Comfort - Junior

Colori

Bianco - Nero

Altezza piatto

H. 8 cm - H. 14 cm

Measurement

80x80 right-left
90x90 right-left
90x90 round
90x70 right-left
100x70 right-left
100x80 right-left
120x80 right-left

Installation

Corner

System

Step - Integra
Comfort - Junior

Colour

White - Black

Shower tray height

8 cm H. - 14 cm H.

Sound Junior - Pannelli piatto H. 8 cm Sound Junior - Shower tray 8 cm H.

- colonna ad angolo
- pareti laterali in cristallo 6 mm
- doccetta con supporto magnetico
- 3 jets idromassaggio
- piatto doccia in acrilico
- chiusura scorrevole finitura brillantata
- cristallo di sicurezza 6 mm
- pannello piatto H 8 cm (prevedere incasso per piletta)
- tetto con soffione
- sedile reclinabile
- radio e erogatore di vapore per bagno turco con display e comandi digitali
- corner installation shower column
- crystal glass wall 6 mm thick
- magnetic hand shower
- n. 3 hydromassage jets
- acrylic shower tray
- crystal glass sliding door 6 mm thick
- shower tray 8 cm height (encased drain required)
- built-in roof head shower
- steam generator with digital control
- display
- radio
- open/close seat





Sound

/ Design **Franco Bertoli**

Cabina doccia multifunzione in cristallo e acciaio Multifunction shower cabin in crystal glass and stainless steel

Dimensioni

80x80 dx-sx
90x90 dx-sx
90x90 tondo
90x70 dx-sx
100x70 dx-sx
120x80 dx-sx
120x80 dx-sx

Installazione

Angolo

Sistemi

Step - Integra
Comfort - Junior

Colori

Bianco - Nero

Altezza piatto

H. 8 cm - H. 14 cm

Measurement

80x80 right-left
90x90 right-left
90x90 round
90x70 right-left
100x70 right-left
100x80 right-left
120x80 right-left

Installation

Corner

System

Step - Integra
Comfort - Junior

Colour

White - Black

Shower tray height

8 cm H. - 14 cm H.

Sound Comfort - Pannelli Piatto H. 14 cm

- cabina doccia multifunzione
- colonna ad angolo
- pareti laterali in cristallo 6 mm
- doccetta con supporto magnetico
- piatto doccia in acrilico
- chiusura scorrevole finitura cromo e in cristallo di sicurezza 6 mm
- pannello piatto H 14 cm
- tetto con soffione
- sedile reclinabile
- erogatore di vapore per bagno turco con comando meccanico (on-off)
- corner installation shower column
- crystal glass wall 6 mm thick
- magnetic hand shower
- n. 3 hydromassage jets
- acrylic shower tray 14 cm height
- built-in roof head shower
- open/close seat
- radio
- steam generator with digital control
- crystal glass sliding door encloser 6 mm thick



DISPOSITIVI E DOTAZIONI

Devices and equipment

Cristalli temperati e profilo cromato.
L'innovazione della colonna con installazione ad angolo.
La comodità della seduta apri e chiudi.

Crystal glass walls with chromed profiles.
Corner installation shower column is the focus point of this shower cabin.
Open/ close seat means comfort and relax.



Sedile reclinabile
Open/close seat

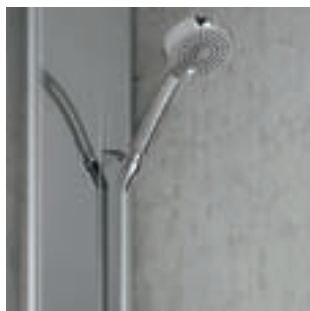

Doccetta con supporto
magnetico
Magnetic hand shower



Piatto doccia H 8 cm
Shower tray 8 cm H



Piatto doccia H 14 cm
Shower tray 14 cm H

Colori pareti box / Box panels colors



Bianco
White



Nero
Black

SISTEMI

Systems

SOUND

Step

Cabina doccia multifunzione - colonna ad angolo
- pareti laterali in cristallo 6 mm - doccetta con supporto magnetico - 3 jets idromassaggio - piatto doccia in acrilico
- chiusura scorrevole finitura brillantata e in cristallo di sicurezza 6 mm - pannello piatto H 8 (prevedere incasso per piletta) /14 cm

Integra

Cabina doccia multifunzione - colonna ad angolo
- pareti laterali in cristallo 6 mm - doccetta con supporto magnetico - 3 jets idromassaggio - piatto doccia in acrilico
- chiusura scorrevole finitura brillantata e in cristallo di sicurezza 6 mm - pannello piatto H 8 (prevedere incasso per piletta) /14 cm - tetto con soffione

Comfort

Cabina doccia multifunzione - colonna ad angolo
- pareti laterali in cristallo 6 mm - doccetta con supporto magnetico - 3 jets idromassaggio - piatto doccia in acrilico
- chiusura scorrevole finitura brillantata e in cristallo di sicurezza 6 mm - pannello piatto H 8 (prevedere incasso per piletta) /14 cm - tetto con soffione - sedile reclinabile - erogatore di vapore per bagno turco con comando meccanico (on-off)

Junior

Cabina doccia multifunzione - colonna ad angolo
- pareti laterali in cristallo 6 mm - doccetta con supporto magnetico - 3 jets idromassaggio - piatto doccia in acrilico
- chiusura scorrevole finitura brillantata e in cristallo di sicurezza 6 mm - pannello piatto H 8 (prevedere incasso per piletta) /14 cm - tetto con soffione - sedile reclinabile - radio e erogatore di vapore per bagno turco con display e comandi digitali

Step

Multifunction shower cabin - corner installation shower column - magnetic hand shower - acrylic shower tray 8 cm H (enclased drain required) / 14 cm - crystal glass sliding door enclosure 6 mm thick - n. 3 hydromassage jets

Integra

Multifunction shower cabin - corner installation shower column - magnetic hand shower - acrylic shower tray 8 cm H (enclased drain required) / 14 cm - crystal glass sliding door enclosure 6 mm thick - built-in roof head shower - n. 3 hydromassage jets

Comfort

Multifunction shower cabin - corner installation shower column - magnetic hand shower - acrylic shower tray 8 cm H (enclased drain required) / 14 cm - crystal glass sliding door enclosure 6 mm thick - built-in roof head shower - open close seat - steam generator - mechanic control - n. 3 hydromassage jets

Junior

Multifunction shower cabin - corner installation shower column - magnetic hand shower - acrylic shower tray 8 cm H (enclased drain required) / 14 cm - crystal glass sliding door enclosure 6 mm thick - built-in roof head shower - open close seat - steam generator - mechanic control - n. 3 hydromassage jets - radio - steam generator with digital control

New Bi-Size

Cabina doccia multifunzione in cristallo e alluminio

Multifunction shower cabin made by crystal glass and aluminium

Dimensioni

80x80
90x90
reversibile 70x90

Installazione

Angolo

Sistemi

Integra
Junior

Measurement

80x80
90x90
reversible 70x90

Installation

Corner

System

Integra
Junior

Integra

Cabina doccia multifunzione - completa di parete attrezzata - miscelatore - asta doccia con doccetta - soffione - nr. 12 jets idromassaggio - piatto doccia con pannello estraibile - piletta con sifone ispezionabile - chiusura in cristallo di sicurezza 6 mm con sgancio anta agevolato - tetto - specchio

Junior

Cabina doccia multifunzione con bagno turco Kw 2,2 con sistema multiclimate - elettronica con diagnostica - visualizzazione temperatura - visualizzazione timer - sistema di decalcificazione caldaia - completa di parete attrezzata - miscelatore - asta doccia con doccetta - soffione - luce alogena - nr. 12 jets idromassaggio effetto pulsato - piatto doccia con pannello estraibile - piletta con sifone ispezionabile - chiusura in cristallo di sicurezza 6 mm con sgancio anta agevolato - tetto - specchio - erogatore vapore con aromaterapia e fitoterapia - allarme

Integra

Multifunction shower cabin - with equipped panel - mixer - handshower on slide bar - headshower - nr. 12 hydromassage jets - shower tray with removable panel - waste with inspectable siphon - safety 6mm crystal enclosure with easy hanging system - roof - mirror

Junior

Multifunction shower cabin with steambath Kw 2,2 with multi-climate system - electronics with diagnostic - temperature display - timer display - anti-limestone system for boiler - equipped panel - mixer - handshower on slide bar - handshower - light - nr. 12 pulsed hydromassage jets - shower tray with removable panel - drain - safety 6 mm crystal enclosure with easy hanging system - roof - mirror





BOX A COMPOSIZIONE

/ Box composition

page 226

Time scorrevole

page 232

Time battente

page 238

Bristol Box

Time

Cabina doccia / Shower cabin

Angolo due ante scorrevoli / Two sliding doors

100 x 70

Una soluzione già pronta che abbina la chiusura battente o scorrevole con allestimenti, piatti e colonne in diverse possibilità. Time è l'ambiente doccia semplice, completo, coordinato e personalizzabile studiato per ogni esigenza.

A ready-made solution that combines a hinged or sliding door with fittings, trays and columns of different types. Time is the simple shower solution that's complete, coordinated and personalisable, designed for any requirement.



Misure disponibili / Available sizes

90x70 / 100x70 / 100x80

- Soffione integrato
- Termostatico
- Doccetta Raining
- Mensola porta oggetti
- Piatto doccia Forma

- Headshower
- Thermostatic
- Handshower Rain effect
- Holding shelf
- Forma shower trays



Time

Cabina doccia / Shower cabin

Un lato scorrevole + fisso / One side sliding + Fixed
120 x 80

Il profilo in finitura brill inquadra la nicchia scorrevole con un design semplice e moderno.

The Brill finish profile gives the alcove with sliding door a simple and modern frame.



Misure disponibili / Available sizes

100x70	100x80	110x90	100x100
110x70	110x80	120x90	120x100
120x70	120x80	140x90	
140x70	140x80		
170x70	170x80		



Time

Cabina doccia / Shower cabin

Porta con un'anta scorrevole / Door with a sliding door
140 x 80

Profili e piatto doccia disegnano una geometria essenziale, con linee sottili ed eleganti.

Shower tray and profiles create a simple type of geometry with subtle, elegant lines.



Misure disponibili / Available sizes

100x70	100x80	110x90	100x100
110x70	110x80	120x90	120x100
120x70	120x80	140x90	
140x70	140x80		
170x70	170x80		



Time

Cabina doccia / Shower cabin

Un lato battente + fisso / A side door + fixed
120 x 80

La maniglia assicura una presa ottimale e si inserisce perfettamente nel gioco di linee minimaliste.

The handle ensures optimum grip and fits perfectly into the play of minimalist lines.



Misure disponibili / Available sizes

90x70	100x80	110x90	100x100
100x70	110x80	120x90	120x100
110x70	120x80	140x90	
120x70	140x80	160x90	
140x70	160x80		



Time

Cabina doccia / Shower cabin

Porta con un'anta battente / Door with a hinged door **140 x 80**

Le cerniere dell'apertura battente sono un elemento funzionale che caratterizza le pareti.

The hinges on the door are a functional element that add character to the walls.



Misure disponibili / Available sizes

100x70	100x80	110x90	100x100
110x70	110x80	120x90	120x100
120x70	120x80	140x90	
140x70	140x80	160x90	
	160x80		



CHIUSURE DOCCIA

Closures shower



SCORREVOLE

Sliding

Angolo due ante scorrevoli
Two sliding doors

Un lato scorrevole + fisso
One side sliding + Fixed

Porta con un'anta scorrevole
Door with a sliding door

Finitura / Finishes:

Prifili brill
brill profile

Vetro 8 mm trasparente
8mm transparency glass

Chiusura rallentata
Soft close

BATTENTE

Swinging

Un lato battente + fisso
A side door + fixed

Porta con un'anta battente
Door with a hinged door

Finitura / Finishes:

Prifili brill
brill profile

Vetro 8 mm trasparente
8mm transparency glass

COLONNE DOCCIA

Shower column



Versione 1



Versione 2



Versione 3

PIATTI DOCCIA

Shower trays

FORMA



5 finiture naturali / 5 natural finishing



Bianco
White

Antracite
Charcoal grey

Cemento
Concrete grey

Moka
Moka

Beige
Beige

ZEROQUATTRO



Bianco
White

Bristol Box

Colonna in acciaio lucido Stainless steel shower column

La magnifica sensazione della cromoterapia, una raffinata pratica di benessere disponibile in tutte le versioni di Bristol. 8 faretti a Led inseriti nella colonna, irradiano la luce alla giusta frequenza per ottenere dai colori gli effetti migliori e dare a questo box una dimensione in più.

The great sensation of colour therapy available in every version of Bristol: n.8 led lights built-in the column brighten shower to get the best performance.



Dotazioni/Equipments

Bristol 1 - Bristol 2 - Bristol 3 - Bristol 4 - Bristol 5 - Bristol 6 - Bristol 7 - Bristol 8

Installazione

Parete
Angolo
Angolo Cristallo
Nicchia

Bristol Box 1 - 140x90

- parete in cristallo di sicurezza 8 mm
- mensola porta oggetti
- soffione incorporato
- miscelatore termostatico
- 3 jets idromassaggio a 3 funzioni
- doccetta raining

Installation

Wall
Corner
Crystal Corner
Niche

A completamento del Box:
- piatto doccia in Corian filo pavimento

- crystal glass wall 8 mm thick
- holding shelves
- thermostatic tap
- 3 hydromassage jets with 3 functions
- handshower rain effect

To completion of the Box:

- flush to floor shower tray in Corian



Bristol Box 1
120x70 / 140x70 / 120x80 / 140x80 / 120x90 / 140x90



Bristol Box 6

Bristol Box 2/3/4/6

70x70 dx-sx	110x70 dx-sx
80x70 dx-sx	120x70 dx-sx
90x70 dx-sx	130x70 dx-sx
100x70 dx-sx	140x70 dx-sx

70x80 dx-sx	110x80 dx-sx
80x80 dx-sx	120x80 dx-sx
90x80 dx-sx	130x80 dx-sx
100x80 dx-sx	140x80 dx-sx

70x90 dx-sx	110x90 dx-sx
80x90 dx-sx	120x90 dx-sx
90x90 dx-sx	130x90 dx-sx
100x90 dx-sx	140x90 dx-sx

Bristol Box 2





Bristol Box 7



Bristol Box 5

Bristol Box 5 / 7

120x70 dx-sx	150x70 dx-sx
130x70 dx-sx	160x70 dx-sx
140x70 dx-sx	170x70 dx-sx

120x80 dx-sx	150x80 dx-sx
130x80 dx-sx	160x80 dx-sx
140x80 dx-sx	170x80 dx-sx

120x90 dx-sx	150x90 dx-sx
130x90 dx-sx	160x90 dx-sx
140x90 dx-sx	170x90 dx-sx



COLONNE DOCCIA

/ Shower column

page 246

Linea Lama

Lama Metallo / Lama Alulife® / Lama Acciaio / Lama Corian®

page 254

Plane

page 258

Brill Plus

page 260

Light / Light Plus

page 262

Bridge Plus

page 264

Linea Etoile

page 270

Rigenera 200

page 272

Quarantacinque

page 274

Quarantacinque S

Linea Lama

/ Design *Franco Bertoli*

Colonna doccia / Shower column

**UNA NUOVA CONCEZIONE
DI COLONNE, IL DESIGN RISCOPRE
LA PUREZZA DELL'ACQUA.**

A new view for shower column, design meets water.



Lama Metallo

/ Design **Franco Bertoli** - **Davide Danielli**

Colonna doccia / Shower column 160 x 20

Il fascino del metallo esalta la bellezza di Lama, proposta nelle finiture champagne o rame, la colonna doccia diventa elemento di arredo e di design.

Fascination of metal emphasise Lama's beauty, proposed in champagne or copper finishing, the shower column becomes now an element of decoration and design.



Lama Metallo

- Finitura rame / champagne
- Soffione integrato
- Rubineria termostatica
- Doccetta raining
- 3 soffioni verticali
- Mensola porta oggetti
- Finishing copper / champagne
- Integrated headshower
- Thermostatic tap
- Handshower with rain effect
- 3 vertical jets
- Holding shelf



Lama Alulife®

- Soffione integrato
- Termostatico
- Doccetta Raining
- 3 soffioni verticali
- Mensola porta oggetti

- Headshower
- Thermostatic
- Handshower Rain effect
- 3 vertical hydromassage jets
- Holding shelf



Lama Alulife® Naturale



Lama Acciaio



Lama Corian®

Lama in Corian® nella versione Plus è dotata di cromoterapia
Lama Corian® Plus with colour therapy



Plane

/ Design *Jan Puylaert*

Colonna doccia / Shower column
142 x 16/36 sp. 3 cm / 3 cm thick

Plane

- Soffione integrato
- Rubinetteria termostatica
- Doccetta raining
- Soffioni verticali
- Mensola porta oggetti
- Integrated headshower
- Thermostatic tap
- Handshower with rain effect
- Vertical jets
- Holding shelf





Plane

/ Design **Jan Puylaert**

Colonna doccia / Shower column

142 x 16/36 sp. 3 cm / 3 cm thick

Ingombro contenuto, funzionalità preservate. Questa è la promessa di Plane, la colonna doccia progettata seguendo i principi dell'ergonomia. Soffioni verticali installati all'altezza ideale permettono di massimizzare i benefici di una doccia di benessere, la rubinetteria termostatica ha la sporgenza ergonomica perfetta, per garantire sicurezza e funzionalità. Struttura in acciaio verniciato nelle finiture bianco opaco, blu cobalto opaco e corallo opaco.

Reduced size, preserved functionality. This is Plane's promise, the ergonomic shower column. The optimal installation of the vertical jets maximize all the benefits of shower, thermostatic tap has a perfect ergonomic protrusion, to ensure safety and functionality. Stainless steel structure, available in the following finishing: matt white, matt cobalt - blue and matt coral.

Plane

- Soffione integrato
- Rubinetteria termostatica
- Doccetta raining
- Soffioni verticali
- Mensola porta oggetti

- Integrated headshower
- Thermostatic tap
- Handshower with rain effect
- Vertical jets
- Holding shelf



Ergonomia / Ergonomics

La particolare forma della colonna, lo spessore di soli 3 cm, la rubinetteria decentrata, rendono il prodotto perfettamente ergonomico e fluidibile.

Particular shape, in a space-saving installation (only 3 cm thick), displaced position faucet, ensure ergonomics and usability.

Finiture / Finishes



Bianco
White



Nero
Black



Blu cobalto
Cobalt - blue



Corallo
Coral



Brill Plus

Colonna doccia / Shower column

Un elegante frontale in cristallo bianco riveste la colonna in acciaio, dotata di due mensole in alluminio con soffione incorporato. L'allestimento è completo di miscelatore termostatico, 3 jets idromassaggio a tre funzioni, doccetta raining, radio e cromoterapia.

An elegant, white crystal glass front panel covers the stainless steel shower column equipped by two aluminium shelves and shower head. The outfitting is completed by a thermostatic tap, 3 hydromassage jets provided with three uses and colour therapy function.

**Materiale
di costruzione**
acciaio inox

Made up by
stainless inox steel

Brill Plus 155x16

- soffione integrato
- miscelatore termostatico
- doccetta Raining
- 3 jets idromassaggio a 3 funzioni:
nebulizzante, pulsato e raining
- mensole porta oggetti
- cromoterapia
- radio

- integrated headshower
- thermostatic tap
- handshower Rain effect
- 3 hydromassage jets provided with
3 uses: nerbulized, pulsed, rain
- holding shelves
- colour therapy
- radio



Light/Light plus

Colonna doccia / Shower column

Il rigore di una forma stilizzata con finitura a specchio, (o in altre 4 versioni) due mensole in alluminio e soffione incorporato con cromoterapia definisce una colonna con miscelatore termostatico, 4 jets idromassaggio, doccetta raining e radio. È disponibile anche il solo soffione con cromoterapia e radio integrati, semplice da installare in ogni contesto.

The precision of form: looking glass finish, (and four other finishes) two aluminium shelves and integrated head shower featuring colour therapy characterize a shower column with thermostatic tap, 4 hydromassage jets, raining shower use and radio. It is also available the headshower without the column, easy to install everywhere.

Light 155x18

- soffione incorporato
- miscelatore termostatico
- doccetta Raining
- nr. 4 jets idromassaggio
- mensole porta oggetti

- built-in headshower
- thermostatic tap
- handshower rain effect
- nr. 4 vertical jets
- holding shelf

Light Plus 155x18

- soffione incorporato con cromoterapia (12 V)
- miscelatore termostatico
- doccetta Raining
- nr. 4 soffioni verticali
- mensole porta oggetti
- radio
- telecomando

- built-in headshower with colour therapy (12 V)
- thermostatic tap
- handshower rain effect
- nr. 4 vertical headshowers
- holding shelf
- radio
- remote control

Finiture / Finishes



Finitura opaca:
ossido, pietra.

Mat finishes:
oxide, stone.

Finitura lucida:
bianco lucido,
alluminio spazzolato champagne

Lacquered finishes:
gloss white,
brushed aluminium champagne

Light 155x18

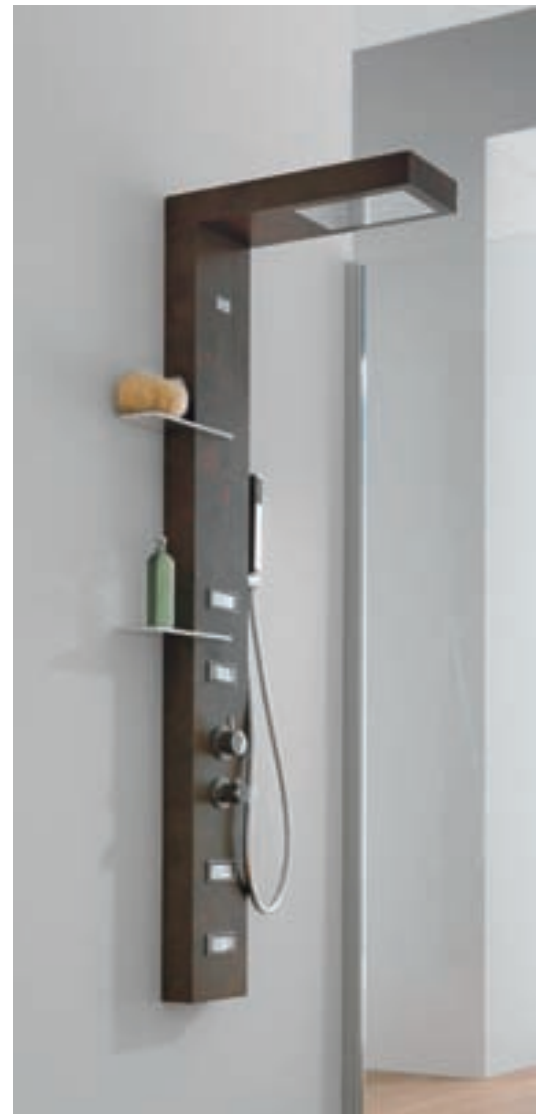

Light Plus 155x18



Bridge Plus

Colonna doccia / Shower column

**Materiale
di costruzione**
acciaio inox

Made up by
stainless inox steel

Bridge Plus 155x16

- soffione integrato
- miscelatore termostatico
- doccetta Raining
- 3 jets idromassaggio a 3 funzioni:
nebulizzante, pulsato e raining
- mensole porta oggetti

- headshower
- thermostatic tap
- handshower Rain effect
- 3 hydromassage jets 3 functions:
nerbulized, pulsed, rain
- holding shelves



Linea Etoile

Colonna doccia / Shower column

Etoile si presenta in due versioni: il modello base con soffione in acciaio e il modello plus con la radio, il soffione luminoso per la cromoterapia e il controllo delle funzioni con display digitale. La colonna è disponibile in tre misure per installazioni a parete o sopra vasca. La versione Etoile 55 è ideale per integrarsi alla rubinetteria già esistente.

Etoile is available in two versions: basic version (stainless steel head shower) and plus version featured by radio, color therapy and digital display. The column is available in three sizes for installations to wall or over the tub. The version Etoile 55 is the ideal solution in order to integrate it to the already existing faucet.

Etoile 160



Etoile 125



Etoile 55



Modello/Model BASE

- soffione in acciaio
- rubinetteria termostatica
- doccetta
- 4 getti idro/3 getti idro + erogatore
- 2 mensole porta oggetti

- headshower
- thermostatic faucet
- handshower
- 4 hydro jets / 3 hydro jets + 1 spout
- 2 holding shelves

Modello/Model PLUS

- soffione con cromoterapia
- rubinetteria termostatica
- doccetta
- 4 getti idro/3 getti idro + erogatore
- 2 mensole porta oggetti
- radio

- headshower with colour therapy
- thermostatic faucet
- handshower
- 4 hydro jets/3 hydro jets + 1 spout
- 2 holding shelves
- radio

Modello/Model BASE

- soffione in acciaio
- rubinetteria termostatica
- doccetta
- 2 getti idromassaggio
- 2 mensole porta oggetti

- headshower
- thermostatic faucet
- handshower
- 2 hydromassage jets
- 2 holding shelves

Modello/Model PLUS

- soffione con cromoterapia
- rubinetteria termostatica
- doccetta
- 2 getti idromassaggio
- 2 mensole porta oggetti
- radio

- headshower with colour therapy
- thermostatic faucet
- handshower
- 2 hydromassage jets
- 2 holding shelves
- radio

Modello/Model BASE

- soffione in acciaio
- deviatore
- doccetta
- 1 mensola porta oggetti

- handshower
- diverter
- handshower
- 1 holding shelf

Modello/Model PLUS

- soffione con cromoterapia
- deviatore
- doccetta
- 1 mensola porta oggetti
- radio

- headshower with colour therapy
- diverter
- handshower
- 1 holding shelf
- radio



Etoile

Colonna doccia / Shower column

Dimensioni

160x21
125x21
55x21

Colori laccati

lucidi
Bianco
Grigio
Bianco - Grigio

Colori opachi

Rosso
Lilla
Antracite

Measurement

160x21
125x21
55x21

Laquered finishes

White
Grey
White - Grey

Matt finishes

Red
Lilac
Anthracite

Etoile Plus Laccato Lucido Bianco-Grigio 160x21
Etoile Plus Lacquered White-Grey 160x21

- soffione con cromoterapia
- radio
- rubinetteria termostatica
- doccia
- 4 getti idromassaggio
- 2 mensole porta oggetti

- headshower with chrome therapy
- radio
- thermostatic faucet
- handshower
- 4 hydromassage jets
- 2 holding shelves

Colori disponibili / Finishes

Laccato lucido / Laquered finishes

Opaco / Matt finishes



Bianco
White



Grigio
Grey



Bianco-Grigio
White-Grey



Rosso
Red



Lilla
Lilac



Antracite
Anthracite



Etoile

Colonna doccia / Shower column

Tra i modelli di Etoile, la 55 è la colonna che si può installare mantenendo la rubinetteria esistente. Compatta e con una mensola porta oggetti, esprime i materiali, colori e le prestazioni della collezione nel minor spazio possibile.

Etoile 55 version represents a column which can be installed whilst still keeping the existing taps and fittings.



Etoile Plus Antracite 55x21

Etoile Plus Opaco Rosso 125x21 Etoile Plus Red 125x21

- soffione con cromoterapia
- radio
- rubinetteria termostatica
- doccia
- 2 getti idromassaggio
- 2 mensole porta oggetti

- headshower with chrome therapy
- radio
- thermostatic faucet
- handshower
- 2 hydromassage jets
- 2 holding shelves

Etoile Plus Antracite 55x21 Etoile Plus Anthracite 55x21

- soffione con cromoterapia
- deviatore
- doccia
- 1 mensola porta oggetti
- radio

- handshower
- diverter
- handshower
- 1 holding shelf
- radio

Etoile Plus Opaco Rosso 125x21



Rigenera 200

Colonna doccia / Shower column
199 x 35 x 11

L'acqua come se scendesse da una cascata, energica, vigorosa, forte.
E' una delle esperienze possibili con la colonna Rigenera 200, un modo deciso
per vivere la doccia quando c'è bisogno di una sensazione piena e gioiosa.

Water as it comes from a fall, energetic, vigorous, strong. It is one of the
possible experiences created by Rigenera 200, a resolute way to live the
shower when you need a full and cheerful feeling.

**Materiale
di costruzione**
acciaio e Corian®
bianco/nero

Made up by
stainless steel
and white/black
Corian®

Rigenera 200

- Miscelatore termostatico
- doccetta Raining
- soffione 35x22 cm
- cascata a velo in acciaio
- 6 jets idromassaggio a 3 funzioni:
nebulizzante, pulsato e raining
- sedile in acciaio e poliuretano
richiudibile
- vano porta oggetti

- thermostatic tap
- rain effect handshower
- headshower 35x22 cm
- stainless steel veil cascade
- 6 hydromassage jets 3 functions:
nebulized, pulsed, rain
- open/close seat
- holding shelf



Finiture / Finishing



Corian® Bianco
White



Quarantacinque

/ Design **Franco Bertoli**

Colonna doccia / Shower column

Installazione ad angolo con soffione integrato e doccia con supporto magnetico.

Corner installation, built in head shower, magnetic hand shower.

Quarantacinque 150 x 21 cm

- miscelatore
- doccia Raining con supporto magnetico
- 3 soffioni verticali
- mensola porta oggetti

- mixer tap
- magnetic handshower
- 3 vertical jets
- holding shelf

Quarantacinque Plus 157 x 21 cm

- soffione integrato
- miscelatore
- doccia Raining con supporto magnetico
- 3 soffioni verticali
- mensola porta oggetti

- built in headshower
- mixer tap
- magnetic handshower
- 3 vertical jets
- holding shelf

Quarantacinque



Quarantacinque Plus



Quarantacinque S

/ Design **Franco Bertoli**



Colonna doccia / Shower column

Quarantacinque S 150 x 21 cm

- miscelatore
- doccetta Raining
 con supporto magnetico
- 3 soffioni verticali
- mensola porta oggetti
- sedile reclinabile

- mixer tap
- magnetic handshower
- 3 vertical jets
- holding shelf
- open/close seat

Quarantacinque S Plus 157 x 21 cm

- soffione integrato
- miscelatore
- doccetta Raining
 con supporto magnetico
- 3 soffioni verticali
- mensola porta oggetti
- sedile reclinabile

- built in headshower
- mixer tap
- magnetic handshower
- 3 vertical jets
- holding shelf
- open/close seat

QuarantacinqueS



QuarantacinqueS Plus





PIATTI DOCCIA

/ Shower trays

page 278
Forma

page 294
Pietrafina

page 298
Corian®

page 302
Zeroquattro

Forma

Piatti doccia / Shower trays

IDEALE PER TUTTI GLI AMBIENTI

Perfect in every location

La resina, unita a miscele minerali, garantisce elevate prestazioni tecniche, ideali per ogni utilizzo domestico o pubblico, sia negli ambienti interni, che in quelli esterni.

The resin combined with mineral mixtures for high technical performance, ideal for any home or public use, both indoors and in those outside.

Spessore h. 2.7 cm
Piatti rettangolari e semicircolari
Dimensioni standard e su misura
Installazione: appoggio o filo
pavimento
Resistente alle macchie
Antibatterico
Antidrucciolo
Resistente all'usura
Resistente agli sbalzi termici e ai
raggi uv

Thickness h. 2.7 cm
Rectangular plates and quadrant
Standard e customized mea-
sures
Installation: mounted or flush to
floor
Stain resistant
Antibacterial
Anti-slip
Wear resistant
Thermal shock and uv rays
resistant

Installazione: appoggio o filo pavimento
Installation: mounted or flush to floor

Appoggio pavimento
On floor installation

Filo pavimento
Flush to floor

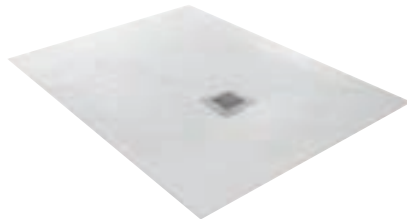
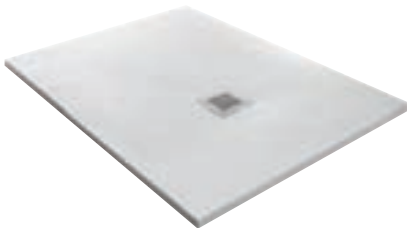

5 finiture naturali / 5 natural finishing



Bianco
White

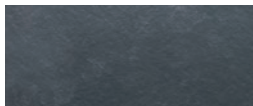

Antracite
Charcoal grey



Cemento
Concrete grey

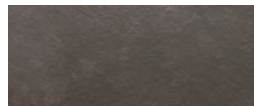

Moka
Moka



Beige
Beige







Forma

Piatti doccia / Shower trays

PIATTO DOCCIA FILO PAVIMENTO

Flush to floor installation

La bellezza dell'effetto pietra si unisce alla sicurezza di un materiale naturalmente antiscivolo.

Good looking stone effect joins safety of a naturally anti-slip material.

Dimensione
120x220 cm

Colore
Cemento

Installazione
Filo pavimento

Measurement
120x220 cm

Color
Concrete grey

Installation
Flush to floor





Forma

Piatti doccia / Shower trays



Dimensione
90x180 cm

Colore
Moka

Installazione
Filo pavimento

Measurement
90x180 cm

Color
Moka

Installation
Flush to floor



Forma

Piatti doccia / Shower trays

PIATTO DOCCIA IN APPOGGIO PAVIMENTO

On floor installation shower tray

La vasta modularità rende FORMA ideale alloggio per ogni tipologia di box doccia.

The wide range of size and the possibility of customized shapes transforms Forma in the ideal accomodation for any type of shower cabin.

Dimensione
100x140 cm

Colore
Bianco

Installazione
appoggio pavimento

Measurement
100x140 cm

Color
White

Installation
On floor installation



PIATTO DOCCIA SEMICIRCOLARE

Curved shower tray

Misure disponibili

80x80 cm
90x90 cm
100x100 cm

Colore
Bianco

Installazione
filo pavimento

Available sizes
80x80 cm R55
90x90 cm R55
100x100 cm R55

Color
White

Installation
Flush to floor



COVER STANDARD O SU MISURA

Piatto doccia H. 3 cm
con copri-piletta finitura pietra

Shower tray H. 3 cm with dry
syphon cover, finish waste

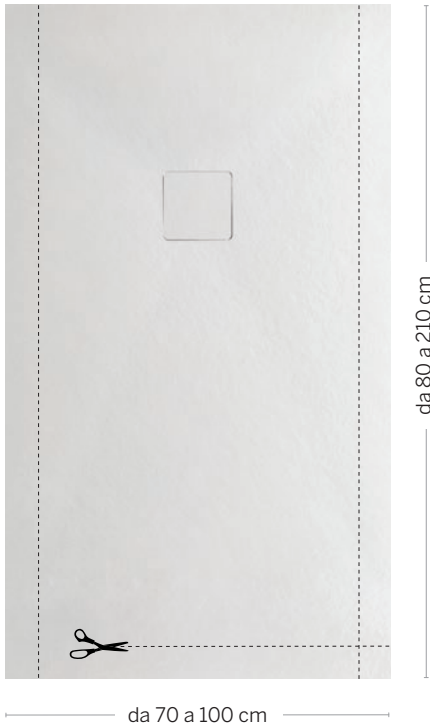

Taglio su misura sui tre lati
Three sides custom cutting

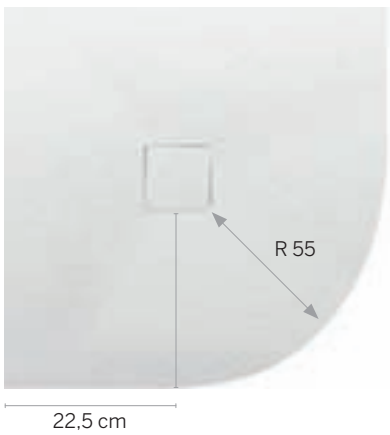

COVER L STANDARD O SU MISURA

Piatto doccia H. 4 cm
con copri-piletta lungo finitura pietra

Shower tray H. 4 cm with rim and
dry syphon cover, finish waste



Taglio su misura su un lato
One side custom cutting





FRAME

Piatto doccia H. 4,5 cm con bordo e copri-piletta in acciaio satinato

Shower tray H. 4,5 cm with rim



FRAME L

Piatto doccia H. 3,5 cm con bordo sui lati esterni con copri-piletta in acciaio satinato

Shower tray H. 3,5 cm with rim on external sides





Forma

Piatti doccia / Shower trays

PANNELLI EFFETTO PIETRA PER FISSAGGIO A PARETE

Stone finish panels for wall installation



5 finiture naturali / 5 natural finishing



Bianco
White

Antracite
Charcoal grey

Cemento
Concrete grey

Moka
Moka

Beige
Beige



Piatti Pietrafina

Piatti doccia / Shower trays
H 4 cm (4 cm h)

ELEGANZA E VERSATILITÀ

Elegance and versatility

Pietrafina è il piatto doccia in Oltremateria®, materiale ricavato da fonti riciclabili ed ecosostenibile, che conferisce al prodotto una finitura materica bianca o grigio cemento.

Pietrafina is a shower tray made of Oltremateria®, a material made of recyclable sources, that gives a material finishing, available in white or concrete grey colour.

Finiture ecomalta / Finishing

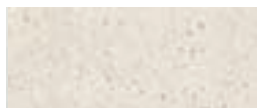

Bianco
White



Terra

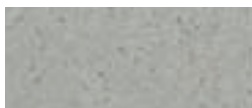

Grigio chiaro



Grigio scuro



RETTANGOLARE

Rectangular



Misure disponibili:

Available sizes:

90x70 cm	120x80 cm
100x70 cm	140x80 cm
120x70 cm	160x80 cm
140x70 cm	120x90 cm
90x75 cm	140x90 cm
90x80 cm	160x90 cm
100x80 cm	

QUADRATO

Square



Misure disponibili:

Available sizes:

80x80 cm
90x90 cm

RETTANGOLARE CURVO (R 38 cm)

Quadrant R 38



Misure disponibili:

Available sizes:

90x70 cm Dx / Sx

100x80 cm Dx / Sx

ANGOLARE CURVO (R 55 cm)

Quadrant R 55



Misure disponibili:

Available sizes:

80x80 cm

90x90 cm

Piatti doccia in Corian®

Piatti doccia / Shower trays



Spessore: h 6 cm
Piatto doccia in Corian con alzatina
Corian shower tray with thickness



Resistenza, igiene, lavorabilità. In sintesi, sono queste le principali qualità del Corian, un materiale tecnologico molto evoluto che permette innumerevoli applicazioni industriali nei più diversi settori. Composto da minerali naturali e polimeri acrilici di elevata purezza, il Corian raggiunge risultati eccezionali per la sua innata versatilità, bellezza e omogeneità, ideali per entrare da protagonista nei box doccia.

Resistance, hygiene, workability. In synthesis, these are the principal qualities of the Corian, a very evolved technological material that permits innumerable industrial applications in the most different sectors. Composed by natural minerals and acrylic polymers of elevated purity, Corian reaches exceptional results for its innate versatility, beauty and homogeneity, ideal to be introduced as protagonist in the shower boxes.



Filopavimento
Piatto doccia in Corian filopavimento
Flush to floor Corian shower tray



SPESSORE: H 6 cm

6 cm thick



Misure disponibili:

Available sizes:

80x80 cm

90x90 cm

100x100 cm

FILOPAVIMENTO

Flush-to-floor



Misure disponibili:

Available sizes:

80x80 cm

90x90 cm

100x100 cm

SPESSORE: H 6 cm

6 cm thick



Misure disponibili:

Available sizes:

120x70	120x80	120x90
130x70	130x80	130x90
140x70	140x80	140x90
150x70	150x80	150x90
160x70	160x80	160x90
170x70	170x80	170x90
180x70	180x80	180x90



Misure disponibili:

Available sizes:

70x70	80x80	90x90	100x100
80x70	90x80	100x90	
90x70	100x80	110x90	
100x70	110x80		
110x70			

FILOPAVIMENTO

Flush-to-floor



Misure disponibili:

Available sizes:

120x70	120x80	120x90
130x70	130x80	130x90
140x70	140x80	140x90
150x70	150x80	150x90
160x70	160x80	160x90
170x70	170x80	170x90
180x70	180x80	180x90



Misure disponibili:

Available sizes:

70x70	80x80	90x90	100x100
80x70	90x80	100x90	
90x70	100x80	110x90	
100x70	110x80		
110x70			

Zeroquattro

Piatto doccia in appoggio pavimento
On floor installation shower tray

La linea Zeroquattro in acrilico rinforzato in vetroresina disegna lo spazio della doccia con forme quadrate, rettangolari o angolari. Resistenti, igienici, di facile pulizia e con il piano inclinato per lo scorrimento dell'acqua. L'altezza di soli 4 cm permette l'installazione sia filopavimento che soprapavimento.

The glass-fibre reinforced acryl line Zeroquattro draws the space of the shower with square, rectangular or corner forms. Resistant, hygienic, easy to clean and with pending plane for facilitated water flowing. The height of 4 cm only allows the installation both flush-to-floor and on the floor.





RETTANGOLARE

Rectangular



Piatto doccia in acrilico rettangolare
Rectangular acrylic shower tray

Misure disponibili:

Available sizes:

90x70	90x75	90x80	120x90
100x70		100x80	140x90
120x70		120x80	160x90
140x70		140x80	
		160x80	

RETTANGOLARE CURVO (R 38 cm)

Quadrant R 38



Piatto doccia in acrilico rettangolare con angolo curvo
Rectangular acrylic shower tray with round corner

Misure disponibili:

Available sizes:

90x70	100x80
dx-sx	dx-sx

QUADRATO

Square



Misure disponibili:

Available sizes:

80x80

90x90

Piatto doccia in acrilico quadrato
Square acrylic shower tray

ANGOLARE CURVO (R 38 cm)

Quadrant R 38



Misure disponibili:

Available sizes:

80x80

90x90

Piatto doccia in acrilico quadrato con angolo curvo
Square acrylic shower tray with round corner



VASCHE IDROMASSAGGIO

✓ Hydromassage tubs

page 314
Linea Sensual

page 324
Linea Bolla

page 348
For All

page 350
Zaphiro

page 351
Oasy

page 352
Linea Mode

page 360
Linea Era

page 366
Eva

page 368
Duo

page 369
Ondaria

page 370
Nemesi

page 371
Gamma

page 372
Old Time

page 373
Armony Plus

page 374
Sinuhè

page 375
Igloo

page 376
Ego

page 377
Diva

page 378
Linea Nova

IDROTERAPIA IN VASCA

Hydrotherapy in tub

La vitalità dell'acqua e la forza dell'aria sono da sempre al centro del programma benessere Hafro. I sistemi Whirpool, Airpool, Whirpool Airpool e Whirpool Airpool Professional assicurano un idromassaggio di qualità sempre in linea con le proprie esigenze. Una tecnologia raffinata applicata alle vasche ed ai box multi funzione crea una molteplicità di configurazioni in grado di modulare a piacere l'effetto tonificante, rassodante e rilassante.

La vitalità dell'acqua e la forza dell'aria sono da sempre al centro del programma benessere Hafro. I sistemi Whirpool, Airpool, Whirpool Airpool e Whirpool Airpool Professional assicurano un idromassaggio di qualità sempre in linea con le proprie esigenze. Una tecnologia raffinata applicata alle vasche ed ai box multi funzione crea una molteplicità di configurazioni in grado di modulare a piacere l'effetto tonificante, rassodante e rilassante.

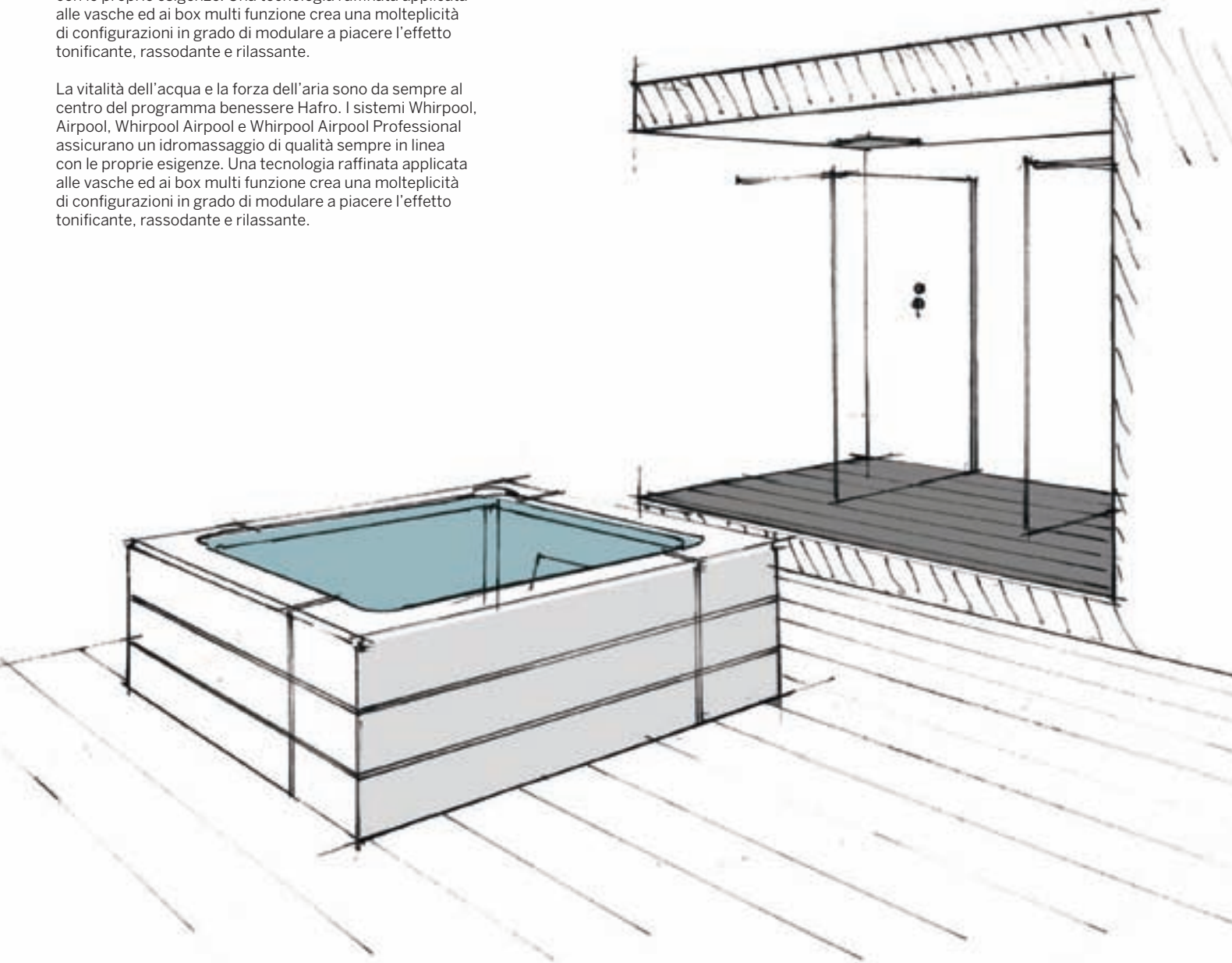



**ALLESTIMENTI
E FUNZIONALITÀ,
PER CHI
CERCA
LO STRAORDINARIO
NEL
QUOTIDIANO.**

Chasing well-being we always discover new dimensions with new models, design and functionality for those of us seeking the extraordinary in everyday life.

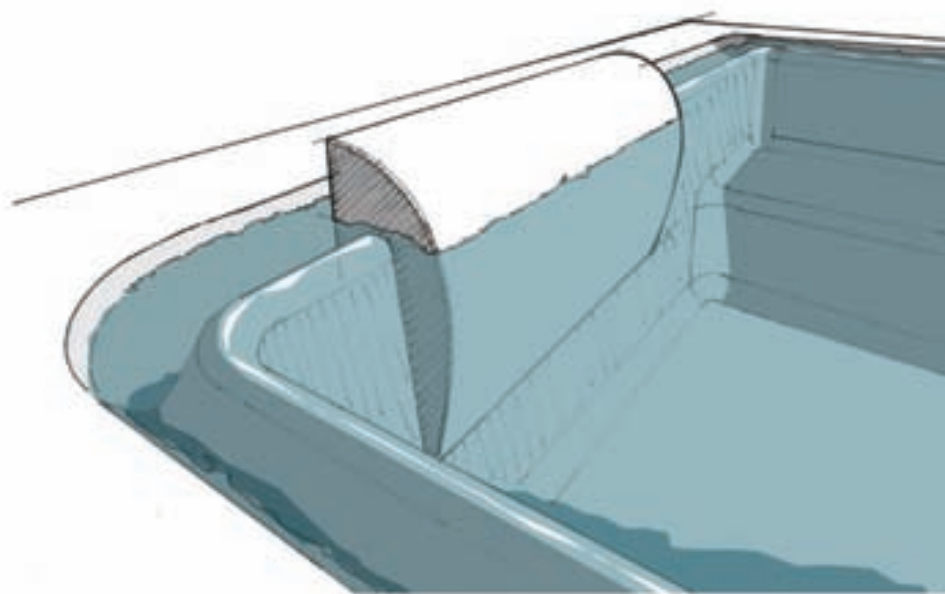

SISTEMI IDROMASSAGGIO

Hydromassage system

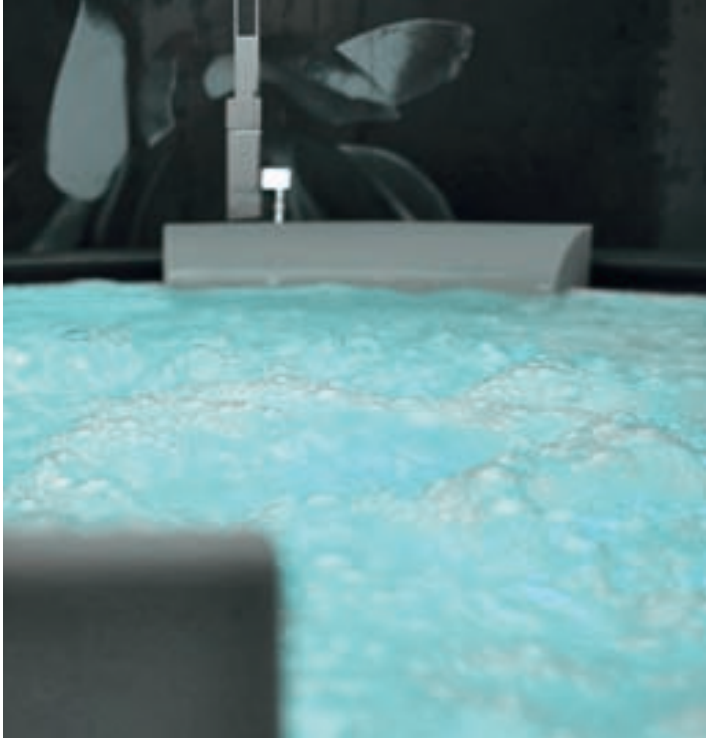

IDROMASSAGGIO AD ARIA

AIRPOOL System



Da una serie di bocchette posizionate a fondo vasca escono infinite micro bollicine d'aria che rilassano in profondità anche chi ha pelle e capillari delicati.

Numerous jets on the bottom of the bathtub produce endless micro air bobbles which deeply relax even sensitive skin and capillaries.

IDROMASSAGGIO AD ACQUA

WHIRLPOOL System



Acqua e aria si riuniscono in un getto ideale per il trattamento vascolare, per riequilibrare il metabolismo dei tessuti e rassodare il corpo.

Water and air gather in an ideal throw for the vascular treatment, to balance the metabolism of tissues and to harden the body.



IDROMASSAGGIO ARIA+ACQUA

WHIRLPOOL AIRPOOL System

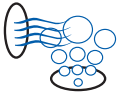

Le due dimensioni dell'idromassaggio insieme per sciogliere le tensioni, tonificare i tessuti e stimolare la circolazione in un approccio globale e completo.

Two different hydromassage system are combined together to dissolve the tensions, to invigorate the tissues and to stimulate the blood circulation in a global and complete approach.

Disinfezione Disinfection

Sistema di disinfezione liquido:

La disinfezione dell'impianto idromassaggio è di serie nei sistemi digitali. Il processo avviene a vasca piena grazie all'uso di liquido disinfettante che agisce in tutte le parti dell'impianto premendo l'apposito tasto che raffigura il simbolo disinfezione.

Liquid disinfection system:

The disinfection of the hydromassage system is standard in digital systems. The process has to be started with full filled tub thanks to a disinfection liquid which will in this way be distributed in the complete system, this process will start pressing the disinfection button.

PROFESSIONAL

PROFESSIONAL WHIRLPOOL AIRPOOL System

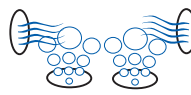

Tutte le funzioni Whirlpool Airpool per un idro massaggio completo e rigenerante.

All the Whirlpool Airpool functions for a complete and regenerating water massage.

Disinfezione con il sistema a diffusione Biosan Disinfection with Biosan diffusion system

Negli impianti idromassaggio manuali la disinfezione (optional) si attiva con il sistema BIOSAN. Il processo avviene mentre si fa l'idromassaggio grazie al passaggio dell'acqua, attraverso un contenitore, di pastiglie di Bromo che mantengono inalterato il PH dell'acqua. Queste pastiglie vanno sostituite ogni 200 cicli di idromassaggio.

The disinfection of the manual hydromassage system (optional) can be done with the system BIOSAN. The process starts during the hydromassage thanks to water going through a plastic tank with Bromo tablets, maintaining the PH of the water unaltered. The tablets have to be reinserted in the plastic tank after 200 hydromassages.



I DETTAGLI DEL RELAX

Indulge in a world of wonderful sensations.

CROMOTERAPIA

Chrome therapy

Agisce sull'organismo mediante l'azione della luce irradiata da appositi faretto. Le diverse frequenze e lunghezze d'onda che ne determinano il colore, rosso, verde, giallo, blu, agiscono a livello cellulare mediante il fenomeno della risonanza favorendo la stimolazione o il rilassamento. Insonnia, stress, dermatiti, disturbi respiratori e digestivi possono trovare giovamento da tali applicazioni.

It acts on the organism through the beneficent action of the green, blue, red and yellow light radiated from special spots. The different frequencies and wavelengths, that determine the colors, directly act to cellular level through the phenomenon of the resonance. The effect of equilibrium is very important and favours both stimulation and relax according to the color. Insomnia, stress, dermatitis, respiratory and digestive troubles can find an immediate relief.



AROMATERAPIA

Aroma therapy

L'utilizzo degli aromi allo scopo di indurre particolari sensazioni è pratica antica ed universalmente diffusa: il profumo dei fiori, gli oli essenziali. Una armonica composizione di profumi accompagna ciascun trattamento di benessere, creando l'ambiente più indicato per ottenere il meglio dall'azione energizzante, rilassante o balsamica che le essenze emanano dagli appositi diffusori.

The use of the aromas to the purpose to induce particular feelings is practical ancient and universally diffused: the perfume of the flowers, the essential oils. An harmonic composition of perfumes accompanies every treatment of comfort, creating the most suitable environment to get the best from the energizing, relaxing or balmy action given by the essences spread by the special diffusers.



Linea Sensual

/ Design **Franco Bertoli**

Una seduta ergonomica frutto di un design fluido e funzionale permette al corpo una posizione di assoluto relax.

Sensual si declina nelle versioni: solo vasca, con lavabo o con spazio doccia.

Realizzata in Corian e dotata di sistema idromassaggio airpool, diventa il centro di una sala da bagno dove l'estetica contemporanea dà un nuovo significato alle funzioni, aprendo orizzonti di stile, comfort e progettualità.

The inside design gives the possibility to lay in an extreme relaxing position. Sensual is available in the versions tub only, with sink or side by side to a dedicated bath space.

Corian made and supplied with airpool hydro-massage system, becomes the heart of bathroom where beauty gives a new meaning to the functions, and open new horizons of style, comfort and project.

Sensual arricchisce l'acqua di nuove sensazioni e l'arredo di nuove potenzialità. La sua forma è un sistema personalizzabile da integrare all'ambiente circostante con tre misure, la possibilità del lavabo nella versione da 250 e dello spazio doccia da affiancare a destra o a sinistra.

Sensual enriches the water of new feelings and furnishing of new potentialities. Its shape is a customizing system born to be integrated to the surrounding environment with three different dimensions, the possibility of the sink in the 250 version and shower space to be placed side by side right or left.

Sensual 180 - 190 - 220 - 250

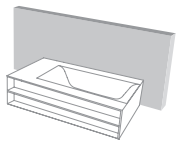

parete
wall

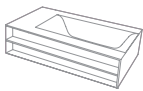

centro stanza (esclusa 250)
free standing (250 excluded)

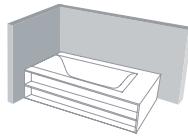

angolo dx-sx
corner right-left

Sensual 250 con lavabo/with sink

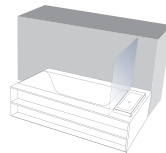

parete dx-sx
wall right-left

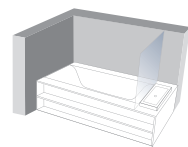

angolo dx-sx
corner right-left



Sensual 250

Vasche idromassaggio Hydromassage tubs

La versione da 250 può essere dotata di lavabo. I due cassettoni hanno le sponde in cristallo temperato. I comandi per la regolazione dell'idromassaggio Airpool sono un ulteriore pregio: incassati nella struttura in Corian si attivano con una semplice e lieve pressione.

250 version can be provided with sink. Two chests have got lateral sides in tempered crystal. Airpool hydro-massage controls are a further merit: built in the structure in Corian, they can be run with a simple and light pressure.

Sensual 250 con lavabo e specchio 250x120 Airpool

Sensual 250 with sink and mirror 250x120 Airpool

- vasca digitale airpool
- 20 iniettori airpool
- programma pulsato airpool
- massaggio microdiffuso elettrosoffiante a velocità regolabile
- faro subacqueo
- air clean system
- sensore di livello
- colonna scarico
- sifone

- airpool digital bathtub
- 20 airpool jets
- airpool pulsed program
- micro-diffused massage by electro-blower with adjustable speed
- underwater light
- air clean system
- level sensor
- drain column
- trap

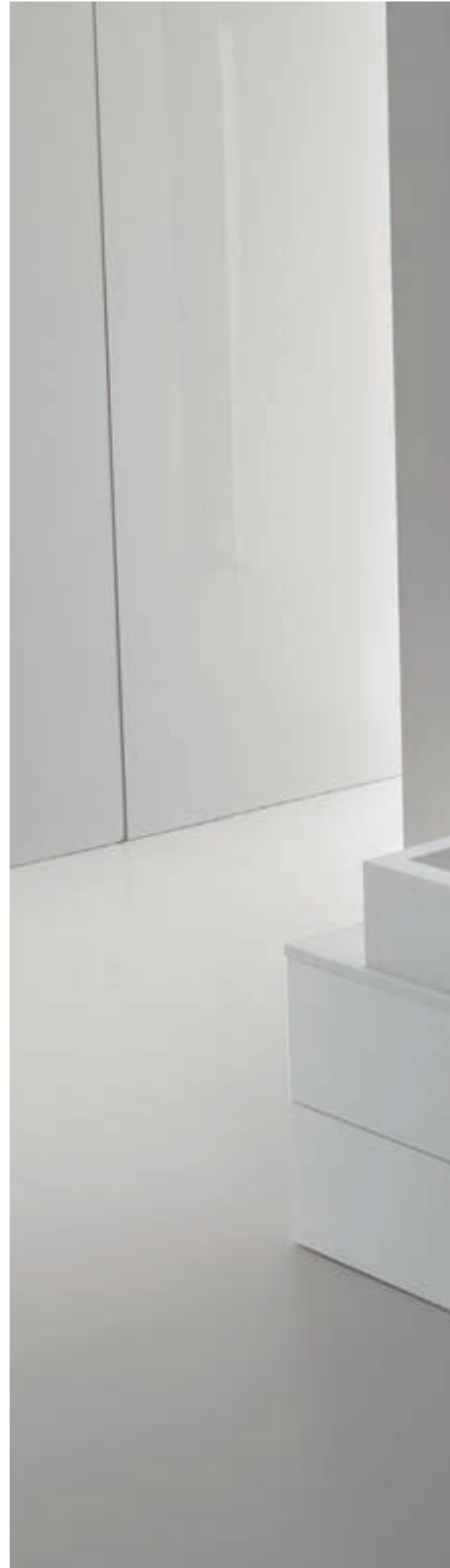



Sensual 220

Vasche idromassaggio
Hydromassage tubs

220x120 Airpool

- vasca airpool
- 20 iniettori airpool
- programma pulsato airpool
- massaggio microdiffuso
 - elettrosoffiante a velocità regolabile
- faro subacqueo
- air clean system
- sensore di livello
- colonna scarico
- sifone

- airpool bathtub
- 20 airpool jets
- airpool pulsed program
- micro-diffused massage by electro-blower
 - with adjustable speed
- underwater light
- air clean system
- level sensor
- drain column
- trap





Sensual 190x100

Vasche idromassaggio
Hydromassage tubs

Sensual 190
190x100 dx-sx
190x90 dx-sx
190x80 dx-sx

190x100 Airpool

- vasca digitale airpool
- 20 iniettori airpool
- programma pulsato airpool
- massaggio microdiffuso
 elettrosoffiante a velocità regolabile
- faro subacqueo
- air clean system
- sensore di livello
- colonna scarico
- sifone

Sensual 180
180x100 dx-sx
180x90 dx-sx
180x80 dx-sx

- airpool digital bathtub
- 20 airpool jets
- airpool pulsed program
- micro-diffused massage by electro-blower
 with adjustable speed
- underwater light spot
- air clean system
- level sensor
- drain column
- trap





Finiture

Finishes

Le finiture della linea Sensual prevedono il rivestimento in MDF laccato in tre ricercate colorazioni (o nelle personalizzazioni RAL), con i ripiani nei modelli più grandi e con pannello liscio negli altri. Nei modelli 250 e 220 la vasca viene accessoriata di cassettiere con profili in cristallo.

Sensual finishes are in lacquered MDF (red, grey, white or customized RAL selection). The bigger version are provided with holding shelves, the smallest with smooth panels. 250/220 models are expanded with dresser in crystal glass finishes.

Pannelli e cassettiere in Mdf laccato*

MDF painted panels*

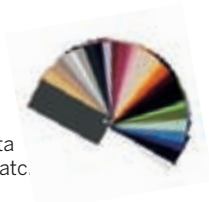

Il laccato è disponibile in tutti i colori della mazzetta
Lacquer available in all colours of the selection swatch.



Tastiera digitale

Digital keypad

Comandi accensione e di regolazione dell'idromassaggio airpool con più o meno intensità sono incassati nella struttura e si attivano con una semplice e lieve pressione.

The commands to turn on and regulate the airpool hydromassage to different levels of intensity are built into the structure and turned on simply with light pressure.



Airpool



Rubinetteria

Faucets

SERIE LOFT

Un design geometrico per la rubinetteria da bordo vasca con tre o quattro fori, doccetta e bocca di erogazione oppure in versione piantana con bocca di erogazione e doccetta.

A geometric design for bath taps with three or four holes, shower head and spout or in the upright version with spout and shower head.



Bolla Q Sfioreo 190x190

/ Design **Franco Bertoli**

Le soluzioni di Bolla Q

Bolla Q selection

Bolla Q è disponibile nelle versioni Airpool, con o senza sistema di ricircolo dell'acqua, Whirpool e Whirpool Airpool. Dotata di riscaldatore e sistema di disinfezione dell'acqua.

Bolla Q is available with Airpool, with or without automatic recirculating water system, Whirpool and Whirpool Airpool systems. It's equipped with heater and water disinfection system.

Bolla Q 190 Sfioreo

Versione Airpool con sistema per il ricircolo dell'acqua.

Airpool system: integrated water tank to get the automatic recirculating water system.

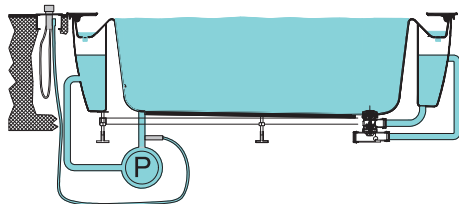

Versione Airpool, Whirpool e Whirpool Airpool senza sistema di ricircolo dell'acqua.

Airpool, Whirpool and Whirpool Airpool system without automatic recirculating water system

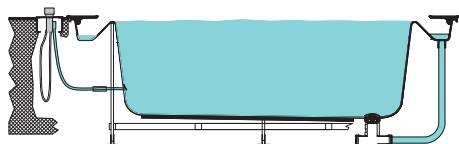



Bolla Q Sfiro 190x190

Vasca quadrata, spaziosa, una minipiscina da interno. Immersione completa del corpo. La gamma Bolla si arricchisce.

Square hydromassage tub, a mini pool for your bathroom or your wellness room and your pleasure. Bolla collection grows up.

Vasche idromassaggio Hydromassage tubs

Bolla Q 190x190 Sfiro Airpool

- sistema automatico di ricircolo
- vasca digitale airpool
- 24 iniettori airpool
- massaggio microdiffuso con elettrosoffiante a velocità regolabile
- cromoterapia (optional)
- air clean system
- piletta di scarico
- riscaldatore
- ozonoterapia
- sistema disinfezione
- sifone
- colonna di scarico a vasi comunicanti

- automatic water purification system
- airpool digital bathtub
- 24 airpool jets
- micro-diffused massage by electro-blower with adjustable speed
- colour therapy (optional)
- air clean system
- drain column
- heater
- ozone therapy
- disinfection system
- trap
- overflow column with communicating vessels





Bolla Q Sfiro

Design **Franco Bertoli**



Vasche idromassaggio / Hydromassage tubs
190 x 190



Bolla Q Sfiro

/ Design **Franco Bertoli**

Il progetto benessere e bellezza si attua nella versione freestanding di Bolla Q Sfiro, con i pannelli in solid surface ad effetto boiserie.

Beauty and wellbeing project improves itself thanks to Bolla Q freestanding edition, with solid surface finishing panels.

Vasche idromassaggio Hydromassage tubs

Airpool con Sistema di ricircolo automatico

Airpool hydromassage with automatic water recirculating system

- 24 iniettori airpool
- massaggio mirodifuso con elettrosoffiante a velocità regolabile
- programma pulsato
- faro subacqueo
- cromoterapia
- air clean system
- sensore di livello
- sistema di disinfezione
- riscaldatore

- 24 airpool jets
- micro-diffused massage by electroblower
- pulsed program
- underwater light spot
- colour therapy
- air clean system
- level sensor
- disinfection system
- heater

Modalità di installazione / Methods of installation



Incasso
recessed



semi incasso
semi recessed



in appoggio ad angolo
in support of corner



in appoggio a parete
in wall-mounted



free standing



Bolla Q 160x160

/ Design **Franco Bertoli**

Vasca da incasso con sistema idromassaggio Airpool, spaziosa ma di dimensioni contenute, è la più piccola della collezione Bolla Q.

Square built-in tub, Airpool system, wide but smaller than the 190one, it's the smallest of the Bolla Q collection.

Vasche idromassaggio Hydromassage tubs

Bolla Q 160x160 Airpool

- vasca digitale airpool
- 24 iniettori airpool
- massaggio microdiffuso con elettrosoffiante a velocità regolabile
- cromoterapia (optional)
- air clean system
- sensore di livello
- piletta di scarico
- riscaldatore
- sistema disinfezione
- sifone
- colonna di scarico a vasi comunicanti

- airpool digital bathtub
- 24 airpool jets
- micro-diffused massage by electro-blower with adjustable speed
- colour therapy (optional)
- air clean system
- level sensor
- drain column
- heater
- disinfection system
- trap
- overflow column with communicating vessels





Bolla R Sfiro 200x150

/ Design *Franco Bertoli*

Vasche idromassaggio
Hydromassage tubs

Bolla R 200x150 Sfiro Airpool

- vasca digitale airpool
- 24 iniettori airpool
- massaggio microdiffuso con elettrosoffiante a velocità regolabile
- cromoterapia (optional)
- air clean system
- colonna di scarico a vasi comunicanti
- riscaldatore

- airpool digital bathtub
- 24 airpool jets
- micro-diffused massage by electro-blower with adjustable speed
- colour therapy (optional)
- air clean system
- overflow column with communicating vessels
- heater





Bolla R 160

/ Design **Franco Bertoli - Davide Danieli**

Vasca da incasso di dimensioni contenute, per adattarsi ad ogni spazio.
Built in tub, minimum amount of space, suitable for every room.

Vasche idromassaggio Hydromassage tubs

Bolla R 162x112 Airpool

- 24 iniettori airpool
 - massaggio microdiffuso con elettrosoffiante a velocità regolabile
 - air clean system
 - sensore di livello
 - sifone
 - colonna di scarico a vasi comunicanti
-
- 24 airpool jets
 - micro-diffused massage by electro-blower with adjustable speed
 - air clean system
 - level sensor
 - trap
 - overflow column with communicating vessels



Bolla Sfioro 190

Vasche idromassaggio Hydromassage tubs

Bolla è l'esito creativo di un design d'avanguardia, sviluppato coniugando tecnica, ergonomia ed estetica. La forma consente un volume eccezionale d'acqua. Il sistema di igienizzazione permette di utilizzarla a lungo, sempre pronta, sempre pulita, sempre con la temperatura giusta grazie ad un sistema di programmazione elettronica con timer.

Il concept si sviluppa in una linea completa con le versioni a sfioro con diametro di 190 cm free standing o con quattro modalità di incasso e nella versione da incasso semplice da 160 cm.

Bolla is the imaginative result of an avant-garde design, born by technique, ergonomics and aesthetics. Its shape contains an exceptional volume of water. The disinfection system grant the use of it for a long time, always ready, always clean, always to the correct temperature thanks to an electronic planning system by timer.

Concept is developed in a complete selection of installation: free standing or with 4 solutions of built in installation. This tub has a diameter of 190 cm, the smallest are at 160 cm and it's available only in built in installation.



Versione Airpool con sistema con serbatoio integrato per il ricircolo dell'acqua.

Airpool version with integrated water tank governing water purification system.



Versione Airpool, Whirlpool e Whirlpool Airpool senza sistema di ricircolo dell'acqua.

Airpool, Whirlpool and Whirlpool Airpool without water purification system.



Bolla Sfioro 190

/ Design **Franco Bertoli - Davide Danieli**

Incantevole ed esclusiva la sensazione di un'immersione completa, con in più le speciali funzionalità dell'idromassaggio Airpool e Whirlpool per un bagno di assoluto benessere.

Complete immersion gives a delightful and unique sensation, further more, airpool/whirlpool hydromassage provide an experience of complete well being.

Vasche idromassaggio Hydromassage tubs

Bolla Sfioro 190ø Airpool

- vasca airpool
 - 24 iniettori airpool
 - programma pulsato
 - massaggio microdiffuso con elettrosoffiante a velocità regolabile
 - cromoterapia (optional)
 - faro subacqueo
 - air clean system
 - sensore di livello
 - sifone
 - colonna di scarico a vasi comunicanti
 - riscaldatore
 - ozonoterapia
 - sistema disinfezione biosan
-
- airpool bathtub
 - 24 airpool jets
 - pulsed program
 - micro-diffused massage by electro-blower with adjustable speed
 - colour therapy (optional)
 - underwater light spot
 - air clean system
 - level sensor
 - trap
 - overflow column with communicating vessels
 - heater
 - ozone therapy
 - biosan disinfection system

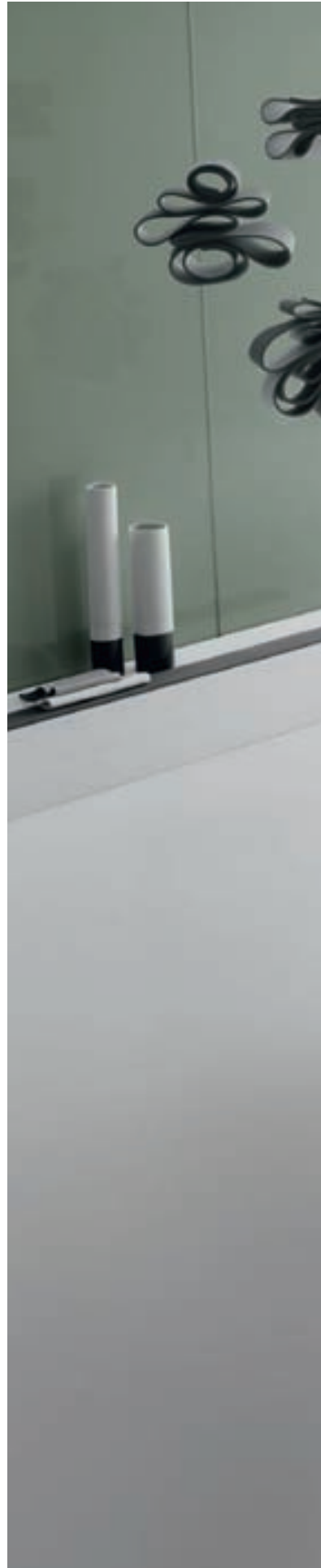







Bolla Sfioro 190 ø

/ Design *Franco Bertoli - Davide Danieli*

Vasche idromassaggio
Hydromassage tubs

UNA FINITURA MATERICA PER UN AMBIENTE MODERNO

Material finishing, for a contemporary ambience

La resina, unita a miscele minerali, garantisce elevate prestazioni tecniche, ideali per ogni utilizzo domestico o pubblico, sia negli ambienti interni, che in quelli esterni.

Bolla becomes a concept for the bathroom. Grey material finishing enriches panels creating a new visual sensation, a new bathroom dimension: contemporary and appealing.

Finiture ecomalta / Finishing

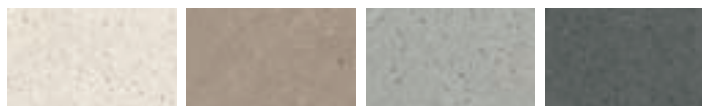

Bianco
White

Terra

Grigio chiaro

Grigio scuro

Bolla 160

Vasche idromassaggio
Hydromassage tubs

Bolla 160 ø Airpool

- vasca airpool
 - 24 iniettori airpool
 - programma pulsato
 - massaggio microdiffuso con elettrosoffiante a velocità regolabile
 - faro subacqueo
 - air clean system
 - sensore di livello
 - colonna di scarico a vasi comunicanti
 - sifone
-
- airpool bathtub
 - 24 airpool jets
 - airpool pulsed program
 - micro-diffused massage by electro-blower with adjustable speed
 - underwater light
 - air clean system
 - level sensor
 - overflow column with communicating vessels
 - trap





Caratteristiche

Features

Bolla Sfiore Ø 190 / Bolla Sfiore 190x190 / Bolla Sfiore R 200x150

La naturalità dell'acqua ispira una linea completa di vasche progettata nella versione a sfioro da 190 cm free standing o con quattro modalità di incasso.

Elegance of water inspires a complete line of tubs: infinity edge, 190 cm diameter, in the free standing version or with four different way of built-in installation.

Bolla Sfiore Ø 190

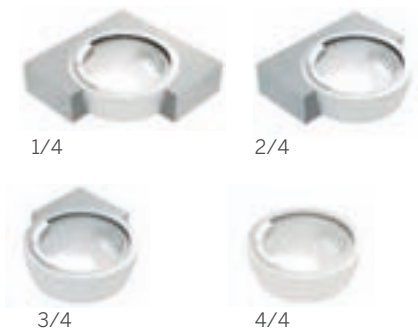

Bolla Sfiore 190x190

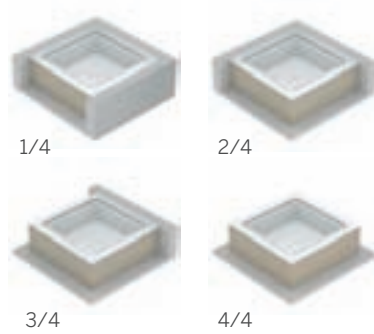

Bolla Sfiore R 200x150

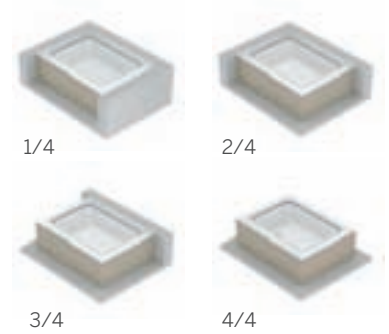

Rubinetteria Bolla Sfiore/Bolla 160

Bolla Sfiore/Bolla 160 taps and fittings

Bolla Sfiore Ø 190 - Bolla 160 con E.T.P.
Bolla Sfiore Q - Bolla Sfiore Q con E.T.P.
Bolla Sfiore R - Bolla Sfiore R con E.T.P.



Bolla Ø 160
Bolla Q
Bolla R

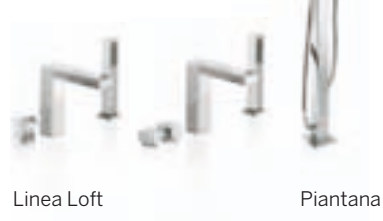

Rubinetteria Bolla/Taps And Fittings Q Sfiore - Bolla Q 160x160



Tastiera digitale

Digital control

Tastiera digitale Bolla Sfiro con ricircolo dell'acqua Digital keypad for Bolla Sfiro with water purification system

Dopo l'accensione con il tasto installato nella vasca, tutte le funzioni si controllano comodamente mediante un telecomando.

Switch on pressing key built in the tub: every function can be easily controlled using hi-tech remote control.



Tastiera digitale Bolla Sfiro senza ricircolo dell'acqua Digital keypad for Bolla Sfiro without water purification system

Le funzioni di idromassaggio della versione senza ricircolo d'acqua si attivano direttamente dalla vasca attraverso un tastiera digitale.

The hydromassage functions, on versions without water purification systems, can be directly activated from the tub itself, using digital keypad.

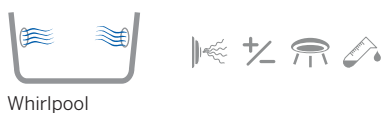

For All

/ Design **Franco Bertoli**

Vasche idromassaggio Hydromassage tubs

Dimensioni
180x78/83 dx-sx

**For All 180X78-83 sx/left bianco/white
Whirlpool Airpool**

Installazione
Angolo

- vasca whirlpool airpool
- chiusura (con porta battente)
in cristallo di sicurezza

Sistemi
Digitale
Airpool
Whirlpool airpool

- 12 iniettori airpool
- 8 jets whirlpool
- faro subacqueo
- air clean system
- massaggio microdiffuso elettrosoffiante
a velocità regolabile
- sistema disinfezione
- colonna di scarico
- sensore di livello
- sifone

Colori
bianco
rosso pompeiano
grigio basalto
(a richiesta
personalizzazione ral)

- whirlpool airpool tubs
- crystal glass shutter door
- 12 airpool jets
- 8 whirlpool jets
- underwater light
- air clean system
- micro-diffused massage electric-blower
with adjustable speed
- disinfection system
- drain column
- level sensor
- trap

Measurement
180x78/83 dx-sx

Installation
Corner

System
Digitale
Airpool
Whirlpool airpool

Colour
white
red
grey
(also available
RAL selection)





Zaphiro

Vasche idromassaggio
Hydromassage tubs

Zaphiro 200x100 Digitale

- Vasca digitale
- 6 getti whirlpool
- igienizzazione
- faro subacqueo
- sensore di livello
- sifone
- colonna di scarico a vasi comunicanti

- Digital bathtub
- 6 whirlpool jets
- disinfection
- underwater light
- level sensor
- trap
- overflow column with communicating vessels

Dimensioni
200x100

Sistemi
Whirlpool
Digitale
Airpool
Whirlpool Airpool
Professional
Whirlpool Airpool

Measurement
200x100

System
Whirlpool
Digitale
Airpool
Whirlpool Airpool
Professional
Whirlpool Airpool



Oasy

Vasche idromassaggio
Hydromassage tubs

Oasy 195x115 Digitale

- Vasca digitale
- 6 getti whirlpool
- igienizzazione
- faro subacqueo
- sensore di livello
- sifone
- colonna di scarico a vasi comunicanti

- Digital bathtub
- 6 whirlpool jets
- disinfection
- underwater light
- level sensor
- trap
- overflow column with communicating vessels

Dimensioni
195x115

Sistemi
Whirlpool
Digitale
Airpool
Whirlpool Airpool
Professional
Whirlpool Airpool

Measurement
195x115

System
Whirlpool
Digitale
Airpool
Whirlpool Airpool
Professional
Whirlpool Airpool



Linea Mode

Vasche idromassaggio Hydromassage tubs

Linea Mode 190x80 Airpool

- vasca digitale airpool
- 16 iniettori airpool
- programma pulsato airpool
- massaggio microdiffuso
- elettrosoffiante a velocità regolabile
- faro subacqueo
- air clean system
- sensore di livello
- colonna scarico
- sifone

- airpool digital bathtub
- 16 airpool jets
- airpool pulsed program
- micro-diffused massage by electro-blower with adjustable speed
- underwater light
- air clean system
- level sensor
- drain column
- trap

Dimensioni
Measurement
190x80
180x90
180x75
170x80
160x90/70





Linea Mode

Mode propone dimensioni ottimali ed una linea accattivante.
La pannellatura laccata è dotata di pratici vani porta oggetti.

Mode exhibits optimal sizes and charming shapes.
Lacquered panels are customized in RAL selection, on the shorter side, in bigger versions there are also 2 holding shelves.





Linea Mode

Vasche idromassaggio
Hydromassage tubs

Linea Mode 180x90 Digitale

- vasca digitale whirlpool
- 8 getti whirlpool
- igienizzazione
- faro subacqueo
- colonna scarico a sifone

- digital whirlpool bath
- 8 whirlpool jets
- steam washing
- underwater spotlight
- drain pipe with trap





180x75 Airpool

- vasca digitale airpool
- 16 iniettori airpool
- programma pulsato airpool
- massaggio microdiffuso elettrosoffiante a velocità regolabile
- faro subacqueo
- air clean system
- sensore di livello
- colonna scarico
- sifone

- airpool digital bathtub
- 16 airpool jets
- airpool pulsed program
- micro-diffused massage by electro-blower with adjustable speed
- underwater light
- air clean system
- level sensor
- overflow column
- trap



160x90/70 Airpool

- vasca digitale airpool
- 16 iniettori airpool
- programma pulsato airpool
- massaggio microdiffuso elettrosoffiante a velocità regolabile
- faro subacqueo
- air clean system
- sensore di livello
- colonna scarico
- sifone

- airpool digital bathtub
- 16 airpool jets
- airpool pulsed program
- micro-diffused massage by electro-blower with adjustable speed
- underwater light
- air clean system
- level sensor
- overflow column
- trap



Linea Era

Vasche idromassaggio Hydromassage tubs

Era 170x70 170x75	Era Plus Professional Whirlpool Airpool 200x120 ad incasso
Era Plus 140x140 180x80 180x120-70 190x90 200x120	<ul style="list-style-type: none">- vasca con telecomando- 8 getti whirlpool- 24 iniettori airpool- intensità idromassaggio whirlpool regolabile- programma pulsato airpool- massaggio microdiffuso- elettrosoffiante a velocità regolabile- programmazione durata- ozonoterapia- faro subacqueo- igienizzazione impianto whirlpool
Sistemi Systems Whirlpool Digitale Airpool Whirlpool Airpool Professional Whirlpool Airpool	<ul style="list-style-type: none">- air clean system- sensore di livello- colonna scarico- sifone- bathtub with remote control- 8 whirlpool jets- 24 airpool jets- adjustable whirlpool hydromassage intensity- airpool pulsed program- micro-diffused massage by electro-blower with adjustable speed- duration planning- ozonotherapy- underwater light- whirlpool disinfection system- air clean system- level sensor- drain column- trap





Linea Era

Vasche idromassaggio
Hydromassage tubs

Era Plus 200x120 Digitale/Digital

- Vasca digitale
- 8 getti whirlpool
- igienizzazione
- faro subacqueo
- sensore di livello
- colonna scarico
- sifone

- Digital bathtub
- 8 whirlpool jets
- disinfection
- underwater light
- level sensor
- drain column
- trap



**Era Plus 180x120/70 sx/left
Digitale/Digital**

- Vasca digitale
- 8 getti whirlpool
- igienizzazione
- faro subacqueo
- sensore di livello
- colonna scarico
- sifone

- Digital bathtub
- 8 whirlpool jets
- disinfection
- underwater light
- level sensor
- drain column
- trap



Linea Era

Vasche idromassaggio
Hydromassage tubs

Era Plus 140x140 Airpool

- vasca airpool
- 16 iniettori airpool
- programma pulsato airpool
- massaggio microdiffuso
 elettrosoffiante a velocità regolabile
- faro subacqueo
- air clean system
- sensore di livello
- colonna scarico
- sifone

- airpool bathtub
- 16 airpool jets
- airpool pulsed program
- micro-diffused massage by
 electro-blower with adjustable speed
- underwater light
- air clean system
- level sensor
- drain column
- trap



Versione con pannellatura in rovere sbiancato
Whitened oak panels version

**Era Plus 190x90 Digitale/Digital
Era 170x75 sx-left Digitale/Digital**

- Vasca digitale
- 8 getti whirlpool
(6 per Era 170x75)
- igienizzazione
- faro subacqueo
- sensore di livello
- colonna scarico
- sifone

- Digital bathtub
- 8 whirlpool jets
(6 for Era 170x75)
- disinfection
- underwater light spot
- level sensor
- drain column
- trap



Eva

Vasche idromassaggio
Hydromassage tubs

Eva 180x80 Sx/Left
Digitale/Digital

- Vasca digitale
- 8 getti whirlpool
- igienizzazione
- faro subacqueo
- sensore di livello
- colonna scarico
- sifone

- Digital bathtub
- 8 whirlpool jets
- disinfection
- underwater light
- level sensor
- overflow column
- trap

Dimensioni
Measurement
180x80
170x70

Sistemi
System
Whirlpool
Digitale
Airpool
Whirlpool Airpool
Professional
Whirlpool Airpool



Eva

Vasche idromassaggio
Hydromassage tubs

Eva 170x70 Sx/Left Digitale/Digital

- vasca airpool
- 16 iniettori airpool
- programma pulsato airpool
- massaggio microdiffuso elettrosoffiante a velocità regolabile
- faro subacqueo
- air clean system
- sensore di livello
- colonna scarico
- sifone

- airpool bathtub
- 16 airpool jets
- airpool pulsed program
- micro-diffused massage by electro-blower with adjustable speed
- underwater light
- air clean system
- level sensor
- drain column
- trap

Dimensioni
Measurement
180x80
170x70

Sistemi
System
Whirlpool
Digitale
Airpool
Whirlpool Airpool
Professional
Whirlpool Airpool



Duo

Vasche idromassaggio
Hydromassage tubs

Duo 170x78 Digitale/Digital

- vasca digitale
- 6 getti whirlpool
- igienizzazione
- faro subacqueo
- sensore di livello
- colonna scarico
- sifone

- digital bathtub
- 6 whirlpool jets
- disinfection
- underwater light
- level sensor
- overflow column
- trap

Dimensioni
Measurement
170x65/78

Sistemi
System
Whirlpool
Digitale
Airpool
Whirlpool Airpool
Professional
Whirlpool Airpool



Ondaria

Vasche idromassaggio
Hydromassage tubs

Ondaria 180x80 Whirlpool/Airpool

- Vasca digitale
- 6 getti whirlpool
- 12 iniettori airpool
- programma pulsato
- massaggio microdiffuso con elettrosoffiante a velocità regolabile
- faro subacqueo
- igienizzazione impianto whirlpool
- air clean system
- sensore di livello
- colonna scarico
- sifone

- Digital bathtub
- 6 whirlpool jets
- 12 airpool jets
- pulsed program
- micro-diffused massage by electroblower with adjustable speed
- underwater light spot
- whirlpool disinfection system
- air clean system
- level sensor
- overflow column
- trap

Dimensioni
Measurement
180x80
170x75
170x70

Sistemi
System
Whirlpool
Digitale
Airpool
Whirlpool Airpool
Professional
Whirlpool Airpool



Nemesi

Vasche idromassaggio
Hydromassage tubs

Nemesi 170x70/85 dx/right
Digitale/Digital

- vasca digitale
- 8 getti whirlpool
- igienizzazione
- faro subacqueo
- sensore di livello
- colonna scarico
- sifone

- digital bathtub
- 8 whirlpool jets
- disinfection
- underwater light
- level sensor
- overflow column
- trap

Dimensioni
Measurement
170x70/85

Sistemi
System
Whirlpool
Digitale
Airpool
Whirlpool Airpool
Professional
Whirlpool Air



Gamma

Vasche idromassaggio
Hydromassage tubs

Gamma 170x76 sx/left Digitale

- vasca digitale
- 6 getti whirlpool
- igienizzazione
- faro subacqueo
- sensore di livello
- colonna scarico
- sifone

- digital bathtub
- 6 whirlpool jets
- disinfection
- underwater light spot
- level sensor
- drain column
- trap

Dimensioni
Measurement
170x70/76

Sistemi
System
Whirlpool
Digitale
Airpool
Whirlpool Airpool
Professional
Whirlpool Airpool



Old Time

Vasca / Bathtub

Old Time 170x80

- vasca con piedini
e colonna scarico con sifone
- piantana a pavimento
- gruppo vasca tipo antico
manopola croce
- tub with feet, drain column
and siphon
- pedestal on floor
- bath group antique style
with cross knobs

Dimensioni
Measurement
170x80



Armony Plus

Vasche idromassaggio
Hydromassage tubs

Armony Plus 140x140 Whirlpool/Airpool

- vasca con impianto digitale Whirlpool
- Airpool completa di telaio
- n.6 idrogetti
- n.12 iniettori airpool
- colonna di scarico normale
- sonda di livello
- cascata cromata
- sifone

- digital whirlpool
- airpool tub with frame
- nr. 6 whirlpool jets
- nr. 12 airpool jets
- drain column
- level sensor
- chrome waterfall tap
- trap

Dimensioni
Measurement
140x40

Sistemi
System
Whirlpool
Whirlpool Airpool



Sinuhé

Vasche idromassaggio
Hydromassage tubs

Sinuhé 165x165 Whirlpool/Airpool

- vasca whirlpool/airpool
- 9 getti whirlpool
- 18 iniettori airpool
- programma pulsato
- massaggio microdiffuso con elettrosoffiante a velocità regolabile
- igienizzazione impianto whirlpool
- air clean system
- faro subacqueo
- sensore di livello
- colonna scarico
- sifone

- whirlpool/airpool bathtub
- 9 whirlpool jets
- 18 airpool jets
- pulsed program
- micro-diffused massage by electro-blower with adjustable speed
- whirlpool disinfection system
- air clean system
- underwater light
- level sensor
- overflow column
- trap

Dimensioni
Measurement
165x165

Sistemi
System
Whirlpool
Digitale
Airpool
Whirlpool Airpool
Professional
Whirlpool Airpool



Igloo

Vasche idromassaggio Hydromassage tubs

Igloo 160x160 Whirlpool/Airpool

- vasca digitale
- 8 getti whirlpool
- 15 iniettori airpool
- programma pulsato
- massaggio microdiffuso con elettrosoffiante a velocità regolabile
- igienizzazione impianto whirlpool
- air clean system
- faro subacqueo
- sensore di livello
- colonna scarico
- sifone

- digital bathtub
- 8 whirlpool jets
- 15 airpool jets
- pulsed program
- micro-diffused massage by electro-blower with adjustable speed
- whirlpool disinfection system
- air clean system
- underwater light
- level sensor
- overflow column
- trap

Dimensioni
Measurement
160x160

Sistemi
System
Whirlpool
Digitale
Airpool
Whirlpool Airpool
Professional
Whirlpool Airpool



Ego

Vasche idromassaggio
Hydromassage tubs

Ego 150x150 Airpool

- Vasca digitale airpool
 - 20 iniettori airpool
 - programma pulsato
 - massaggio microdiffuso con elettrosoffiante a velocità regolabile
 - faro subacqueo
 - air clean system
 - sensore di livello
 - colonna scarico
 - sifone
-
- Airpool digital bathtub
 - 20 airpool jets
 - pulsed program
 - micro-diffused massage by electro-blower with adjustable speed
 - underwater light spot
 - air clean system
 - level sensor
 - overflow column
 - trap

Dimensioni
Measurement
150x50

Sistemi
System
Whirlpool
Digitale
Airpool
Whirlpool Airpool
Professional
Whirlpool Airpool



Diva

Vasche idromassaggio
Hydromassage tubs

Igloo 160x160 Whirlpool/Airpool

- Vasca digitale
- 7 getti whirlpool
- 12 iniettori airpool
- programma pulsato
- massaggio microdiffuso con elettrosoffiante a velocità regolabile
- igienizzazione impianto whirlpool
- air clean system
- faro subacqueo
- sensore di livello
- colonna scarico
- sifone

- Digital bathtub
- 7 whirlpool jets
- 12 airpool jets
- pulsed program
- micro-diffused massage by electro-blower with adjustable speed
- whirlpool disinfection system
- air clean system
- underwater light spot
- level sensor
- overflow column
- trap

Dimensioni
Measurement
140x40

Sistemi
System
Whirlpool
Digitale
Airpool
Whirlpool Airpool
Professional
Whirlpool Airpool



Linea Nova

Vasche idromassaggio Hydromassage tubs

170x70 Whirlpool/Airpool

- vasca whirlpool/airpool
- 6 getti idromassaggio
- 12 iniettori airpool
- colonna scarico
- sensore di livello
- sifone

- digital bathtub whirlpool/airpool
- 6 jets
- 12 airpool jets
- drain column
- level sensor
- trap

Dimensioni

Measurement

- 140x140-120x120
- 160x100
- 180x80
- 170x80
- 170x70
- 170x65
- 160x70
- 160x65
- 150x70
- 140x70
- 120x70

Installazione

Installation

- Angolo - Parete
- Corner - Wall

Sistemi

System

- Whirlpool
- Digitale
- Airpool
- Whirlpool Airpool

Colore

Colour

- Bianco
- White



180x80 Whirlpool

- vasca whirlpool
- regolazione aria
- 6 getti idromassaggio
- colonna scarico
- sensore di livello
- sifone

- whirlpool bathtub
- air regulation
- 6 jets
- drain column
- level sensor
- trap



Linea Nova

Vasche idromassaggio
Hydromassage tubs

160x100 Whirlpool

- vasca whirlpool
- regolazione aria
- 6 getti idromassaggio
- colonna scarico
- sensore di livello
- sifone

- whirlpool bathtub
- air regulation
- 6 jets
- drain column
- level sensor
- trap



140x140 Whirlpool/Airpool

- vasca digitale whirlpool/airpool
- 6 getti idromassaggio
- 12 iniettori airpool
- colonna scarico
- sensore di livello
- sifone

- digital bathtub whirlpool/airpool
- 6 jets
- 12 airpool jets
- drain column
- level sensor
- trap



La rubinetteria

Faucet

Forme cilindriche o squadrate. Le due linee di rubinetteria coordinata esprimono con un design moderno e raffinato due diversi concetti estetici, due scuole di pensiero per interpretare la vasca con il proprio gusto, a quattro o tre fori.

Cylindrical or square shapes. According with their modern and sophisticated design, with four or three holes, they express two different aesthetical concepts, two schools of thought to interpret the tub with a proper own taste.

Linea Prestige



Linea Loft



Linea Nova/Armony Plus/Gea





Comandi

Controls

Telecomando professional Whirlpool Airpool Remote control professional Whirlpool Airpool

Totalmente impermeabile, tanto che può essere tranquillamente immerso nell'acqua. Facilmente utilizzabile, tanto da rendere immediatamente accessibili i comandi Whirlpool Airpool. Il telecomando Professional è tecnologia della comodità.

It is so much easy to use it that you can immediately access to the Whirlpool Airpool functions. The remote control Professional is technology of the comfort.

Comandi a bordo vasca / Control on the edge of the tub

A bordo vasca, semplici comandi rendono facilmente controllabili le funzionalità dell'idromassaggio, siano esse Airpool, Whirlpool o Whirlpool Airpool. Le tre diverse tipologie hanno specifiche mascherine con relativi e intuitivi simboli.

On the tub edge, simple controls make the hydromassage functions easy to check, even they are Airpool, Whirlpool or Whirlpool Airpool system. The three different typologies have specific masks with and intuitive symbols.

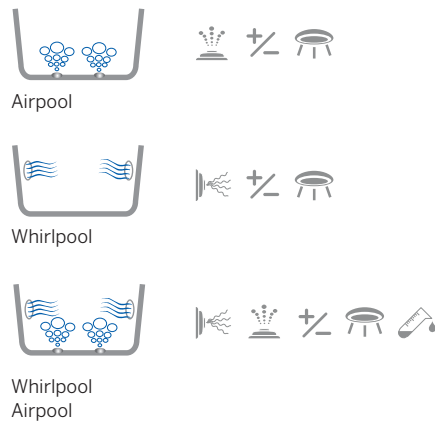

Comando manuale whirlpool / Mechanic whirlpoll control

Il comando manuale segue il design delle rubinetterie Hafro nella versione cilindrica e quadrata per un perfetto coordinamento.

The manual command follows the design of the faucet Hafro in the cylindrical and square version for a perfect coordination.



Whirlpool



Whirlpool - Airpool

Comando digitale / Digital control

Per vasche linea Nova - Armony Plus - Gea
For Nova - Armony Plus - Gea tubs

Pannelli per vasche

Panels for tubs

Finitura legno / Wood finishing

La pannellatura può essere in finitura legno nelle varianti: teak, rovere sbiancato e wengè, dando così uno stile ben definito nel contesto del bagno.

The panelling can be with wood finishing in the shades of teak, bleached oak and wengè, to give a distinct style in the context of the bathroom.

Modelli Eva/Linea Era (esclusa/escluded 180x120/70)

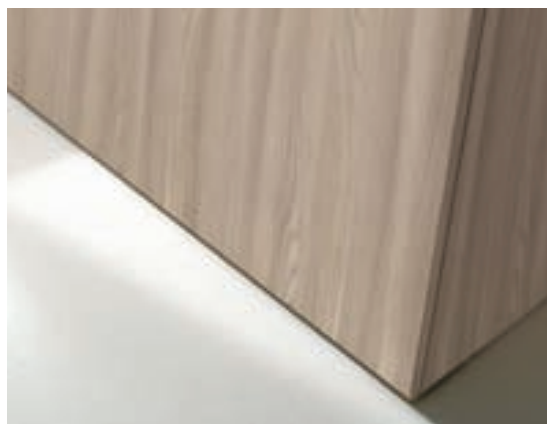

Pannelli laccati / Lacquered Panels

È possibile ordinare i pannelli laccati nelle finiture della gamma RAL per i modelli delle linee Sensual, Mode, Era, Eva.

It's possible to require RAL selection customized lacquered panels for Mode, Era and Eva tubs.

Colorati / Painted

Sul modello Era plus 180x120/70 è disponibile la pannellatura laccata nei colori rosso o nero.

Lacquered boards in red or black model are available on Era Plus 180x120/70.

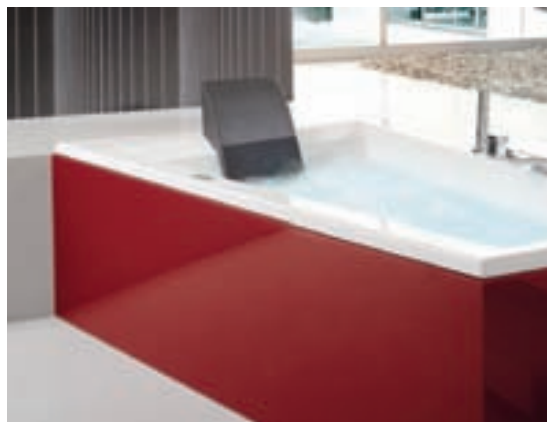

Rivestibili in mosaico o piastrelle In mosaic or tiles dressable

La pannellatura è predisposta per essere rivestita con mosaico o piastrelle, proseguendo così la finitura delle pareti con un suggestivo effetto di continuità.

The panelling is arranged to be covered with mosaic or tiles, the same of the finishing of the walls with a suggestive effect of continuity.

Modelli Eva/Linea Era (esclusa/escluded 180x120/70)





VASCHE COMBIMATE

/ Washtubs with crystal glass shower cabin

page 388

For All Box

page 392

Era Plus Box/Era Box

page 396

Duo Box

page 397

Linea Nova Box

For All Box

/ Design **Franco Bertoli**

Vasche combinate / Buthtubs with cabin

Dimensioni
180x78/83 dx-sx

For all box 180x78/83 sx/left

Installazione
Angolo

Sistemi
Digitale
Airpool
Whirlpool Airpool

Colori
Bianco
Rosso pompeiano
Grigio basalto
(a richiesta
personalizzazione
RAL)

Measurement
180x78/83 dx-sx

Installation
Corner

System
Digitale
Airpool
Whirlpool Airpool

Colour
White - Red - Grey
(on request
customized
RAL colors)

- vasca whirlpool airpool
- chiusura (con porta battente) in cristallo di sicurezza
- 12 iniettori airpool
- 8 jets whirlpool
- faro subacqueo
- asta doccia con doccetta (optional)
- miscelatore a muro (optional)
- air clean system
- massaggio microdiffuso elettrosoffiante a velocità regolabile
- sistema disinfezione
- sensore di livello
- sifone
- kit profilo bordo vasca
- whirlpool airpool tub
- crystal glass shutter door
- 12 airpool jets
- 8 whirlpool jets
- underwater light
- shower rod with handshower (optional)
- mixer tap (optional)
- air clean system
- micro-diffused massage electric-blower with adjustable speed
- disinfection system
- level sensor
- trap
- bowl edge profile kit





For All Box

/ Design **Franco Bertoli**

I pannelli laccati racchiudono in 180x78/83 cm un concentrato di tecnologia: 8 getti whirlpool, 12 iniettori airpool, i comandi a filo bordo vasca, la rubinetteria cilindrica "mini" e la porta in cristallo stratificato.

Lacquered panels enclose high technology of this tub: 180x78/83 cm, 8 Whirlpool jets and 12 Airpool jets.

The controls are on the edge of the bathtub and tap is in mini-version to give a good-looking effect.



Utilizzo come vasca combinata.
Use as tubs with cabin.



Utilizzo come vasca.
Use as a bath.



Apertura totale per facilitare l'accesso.
Total opening for easy access.





Era Plus Box

Il modello Era 180x120/70 diventa vasca combinata con la nuova versione Plus Box. Le ante apribili in cristallo temperato di sicurezza da 6 mm creano linee essenziali in un ambiente doccia comodo e funzionale. La vasca ha tutti gli allestimenti della collezione.

ERA PLUS 180x120/70 becomes combined tub with the new version Plus Box. Openable crystal glass doors are 6 mm thick, they create essential lines and a comfortable and functional shower area. This tub can be provided with all the equipment of the collection.

Linea Era

Vasche combinate / Buthtubs with cabin

Dimensioni 180x120/70 dx-sx	Era Plus Box 180x120/70 sx/left
Installazione Angolo	- vasca con box in cristallo - 8 getti whirlpool - 24 iniettori airpool - ozonoterapia
Sistemi Whirlpool Digitale Airpool Whirlpool Airpool Professional Whirlpool Airpool	- faro subacqueo - sensore di livello - colonna doccia e soffione incorporato - miscelatore termostatico - doccetta raining - sistema igienizzazione - air clean system - telecomando - sifone
Measurement 180x120/70 dx-sx	- kit profilo bordo vasca
Installation Corner	- bathtub and crystal glass cabin - 8 whirlpool jets - 24 airpool jets - ozone therapy - underwater light
System Whirlpool Digitale Airpool Whirlpool Airpool Professional Whirlpool Airpool	- level sensor - shower column and built-in headshower - thermostatic tap - deviator - hand shower - hygiene system - air clean system - remote control - trap - bowl edge profile kit

Era Box Era Plus Box

Linea Era

Vasche combinate / Buthtubs with cabin

Dimensioni

Era Box:

170x70 dx-sx

170x75 dx-sx

Era Plus Box:

180x80 dx-sx

190x90 dx-sx

Installazione

Angolo-Parete

Sistemi

Whirlpool

Digital

Airpool

Whirlpool Airpool

Professional

Whirlpool Airpool

Measurement

Era Box:

170x70 dx-sx

170x75 dx-sx

Era Plus Box:

180x80 dx-sx

190x90 dx-sx

Installation

Corner-Wall

System

Whirlpool

Digital

Airpool

Whirlpool Airpool

Professional

Whirlpool Airpool

Era Plus Box 190x90 sx/left

- vasca con telecomando
- 8 getti whirlpool
- 24 iniettori airpool
- intensità idromassaggio whirlpool regolabile
- programma pulsato airpool
- massaggio microdiffuso
- elettrosoffiante a velocità regolabile
- programmazione durata
- ozonoterapia
- faro subacqueo
- box in cristallo completo di colonna in acciaio lucido
- soffione incorporato
- miscelatore termostatico
- deviatore
- erogatore
- doccetta Raining
- kit profilo bordo vasca
- igienizzazione impianto whirlpool
- sensore di livello
- colonna scarico
- sifone
- kit profilo bordo vasca
- bathtub with remote control
- 8 whirlpool jets
- 24 airpool jets
- adjustable whirlpool hydromassage intensity
- pulsed airpool program
- micro diffused massage
- electro-blower with adjustable speed
- duration planning
- ozonotherapy
- underwater light
- crystal glass cabin
- built-in headshower
- thermostatic
- deviator
- spout
- handshower rain effect
- profile kit for bathtub edge
- whirlpool disinfection system
- level sensor
- drain column
- trap
- kit profilo bordo vasca



Duo Box

Vasche combinate / Buthtubs with cabin

Dimensioni
170x65/78

Installazione
Angolo

Sistemi
Whirlpool
Digitale
Airpool
Whirlpool Airpool

Measurement
170x65/78

Installation
Corner

System
Whirlpool
Digitale
Airpool
Whirlpool Airpool

Duo Box 170X78 Sx/left

- vasca idromassaggio whirlpool
- aria manuale
- 6 getti whirlpool
- kit profilo bordo vasca
- box in cristallo completo di colonna attrezzata
- miscelatore
- asta doccia con doccetta
- deviatore
- erogatore
- idromassaggio verticale pulsato 6 jets
- sensore di livello
- whirlpool bathtub
- air regulation
- 6 whirlpool jets
- profile kit for tub edge
- crystal cabin with equipped column
- mixer
- handshower on slide bar
- deviator
- spout
- vertical pulsed hydromassage with 6 jets
- level sensor



Linea Nova Box

Vasche combinate / Buthtubs with cabin

Dimensioni

140x70
150x70
160x70
170x70
170x80
180x80

Installazione

Angolo

Sistemi

Whirlpool
Whirlpool Airpool

Measurement

140x70
150x70
160x70
170x70
170x80
180x80

Installation

Corner

System

Whirlpool
Whirlpool Airpool

Nova Box - whirlpool

Vasca digitale - n.6 idrogetti - sonda di livello - box in cristallo di sicurezza con due pareti apribili

Digital tub - 6 whirlpool jets - level sensor - crystal glass cabin with 2 openable doors

Nova Box - Whirlpool Airpool

Vasca digitale - n.6 idrogetti - n.12 iniettori airpool - sonda di livello - box in cristallo di sicurezza con due pareti apribili

Digital tub - 6 whirlpool jets - 12 airpool jets - level sensor - crystal glass cabin with 2 openable doors



VASCHE AD INCASSO

/ Built-in tubs

page 400
Bolla Q

page 400
Bolla

page 400
Bolla R

page 400
Igloo

page 400
Sinuhè

page 400
Ego

page 400
Era

page 400
Diva

page 401
Nova

page 401
Armony Plus

page 401
Zaphiro

page 401
Oasy

page 402
Mode

page 402
Eva

page 402
Era plus / Era

page 403
Ondaria

page 403
Duo

page 403
Nemesi

page 404
Gamma

page 405
Nova

Bolla Q 160x160



Sinuhè 165x165



Bolla 160



Ego 150x150



Bolla R 160



Era Plus 140x140



Igloo 160x160



Diva 140x140



Nova 140x140



Nova 160x100 dx-sx



Armony Plus (con cascata cromo) 140x140



Zaphiro 200x100



Nova 120x120



Oasi 195x115



Mode 190x80 dx-sx



Mode 180x90



Mode 180x75



Mode 170x80 dx-sx



Mode 160x90/70 dx



Mode 160x90/70 sx



Era Plus 180x120/70 dx



Era Plus 180x120/70 sx



Era Plus 200x120



Era Plus 190x90



Era Plus 180x80



Era 170x75



Ondaria 170x75



Era 170x70



Ondaria 170x70



Eva 180x80



Duo 170x65/78



Eva 170x70



Nemesi 170x70/85 dx



Ondaria 180x80



Nemesi 170x70/85 sx



Gamma 170x70/76 dx



Nova 180x80



Gamma 170x70/76 sx



Nova 170x80



Nova 170x70



Nova 170x65



Nova 160x70



Nova 160x65



Nova 130x70



Nova 150x70



Nova 120x70



Nova 140x70



Nova 110x70



